

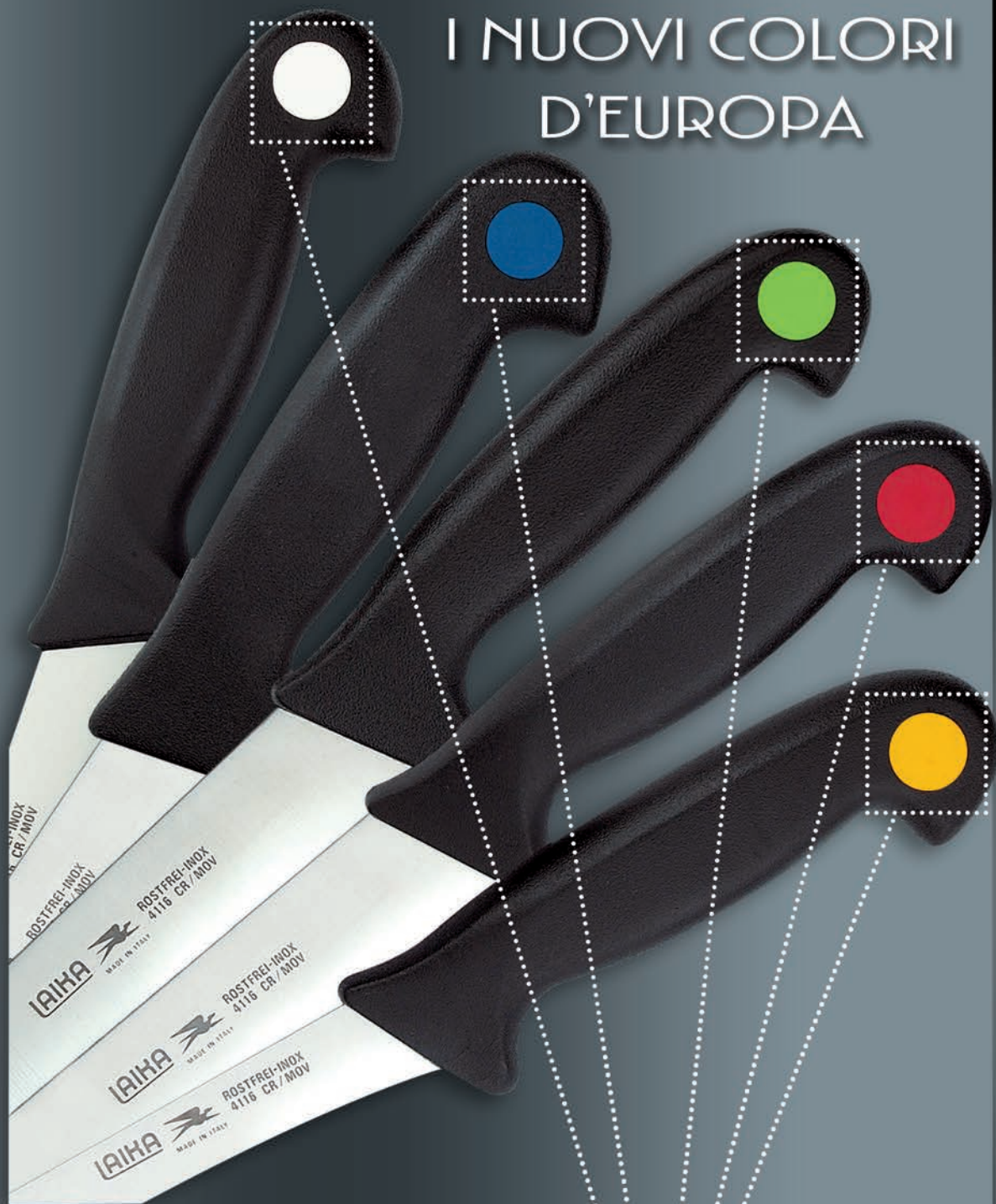

Articoli Professionali da Taglio
Cut Professional Items



I NUOVI COLORI D'EUROPA



In accordo con la nuova normativa HACCP*, tramite la codifica a mezzo colori, si elimina la migrazione batteriologica tra i vari alimenti.

In agreement with the new HACCP rules, cross contamination in food preparation can be controlled by using the right coloured knife.*

* Hazard and Analysis Critical Control Point-concept

LM00515 **016** CODICE LAIKA / LAIKA CODE

Per ordinare la nuova serie **COLORCUT** sostituire alla posizione evidenziata il numero del colore desiderato.

*To order the new collection **COLORCUT** enter the number of the desired colour in the marked position.*

- | | | |
|----------|---|---|
| 1 |  | bianco - pane e formaggi
white - dairy / bakery |
| 2 |  | blu - pesce
blue - raw fish |
| 3 |  | verde - frutta e verdura
green - salad / fruit |
| 4 |  | rosso - macelleria
red - raw meat |
| 5 |  | giallo - carne e alimenti cotti
yellow - cooked meat |

COLORCUT

SERIES

LM00750021

Affilatoio cucina orig. inglese cm. 21
Household steel

**LM00750024**

Affilatoio cucina orig. inglese cm. 24
Household steel

**LM00755031**

Affilatoio prof. tondo orig. inglese cm. 31
Sharpening steel

**LM00756031**

Affilatoio prof. ovale orig. inglese cm. 31
Sharpening steel

**LM00757031**

Affilatoio prof. tondo, diamantato, orig. inglese cm. 31
Sharpening diamond steel

**LM00758031**

Affilatoio prof. ovale, diamantato, orig. inglese cm. 31
Sharpening diamond steel

**LM00553013**

Scuoio per ovini cm. 13
Sheep skinning knife

**LM00512012**

Disosso curvo cm. 12
Boning knife, curved blade

**LM00512015**

Disosso curvo cm. 15
Boning knife, curved blade



**LM00510014**

Coltello disosso stretto cm. 14
Boning knife

**LM00510016**

Coltello disosso stretto cm. 16
Boning knife

**LM00515016**

Coltello disosso largo cm. 16
Boning knife

**LM00515018**

Coltello disosso largo cm. 18
Boning knife

**LM00520016**

Coltello disosso tipo Emilia cm. 16
Boning knife

**LM00540016**

Coltello macellaio cm. 16
Butcher's knife

**LM00540018**

Coltello macellaio cm. 18
Butcher's knife

**LM00540020**

Coltello macellaio cm. 20
Butcher's knife

**LM00540022**

Coltello macellaio cm. 22
Butcher's knife

**LM00540026**

Coltello macellaio cm. 26
Butcher's knife

**LM00540030**

Coltello macellaio cm. 30
Butcher's knife

**LM00540034**

Coltello macellaio cm. 34
Butcher's knife



Lame in acciaio inossidabile al cromo - molibdeno - vanadio.
Manico in plastica semirigida antiscivolo (Megol), resistente da -20° a +140°

Chromium molybdenum vanadium stainless steel blades.
No-slip semirigid plastic handle (Megol), resisting the temperature from -20° to +140°

MEGOL
SERIES

**LM00545018**

Coltello macellaio mezzo largo cm. 18
Wide blade butcher's knife

**LM00545020**

Coltello macellaio mezzo largo cm. 20
Wide blade butcher's knife

**LM00545022**

Coltello macellaio mezzo largo cm. 22
Wide blade butcher's knife

**LM00545030**

Coltello macellaio mezzo largo cm. 30
Wide blade butcher's knife

**LM00545034**

Coltello macellaio mezzo largo cm. 34
Wide blade butcher's knife

**LM00548016**

Coltello macellaio largo cm. 16
Wide blade butcher's knife

**LM00548018**

Coltello macellaio largo cm. 18
Wide blade butcher's knife

**LM00548020**

Coltello macellaio largo cm. 20
Wide blade butcher's knife

**LM00548034**

Coltello macellaio largo cm. 34
Wide blade butcher's knife



Lame in acciaio
 inossidabile al
 cromo - molibdeno -
 vanadio.
 Manico in plastica
 semirigida
 antiscivolo (Megol),
 resistente da
 -20° a +140°

*Chromium
 molybdenum
 vanadium
 stainless steel
 blades.
 No-slip semirigid
 plastic handle
 (Megol), resisting
 the temperature
 from -20° to +140°*

MEGOL
 SERIES

**LM00619030**

Coltello prosciutto stretto cm. 30
Ham slicer

**LM00620030**

Coltello salmone cm. 30
Ham slicer scalloped edge

**LM00618030**

Coltello prosciutto largo cm. 30
Ham slicer

**LM00618036**

Coltello prosciutto largo cm. 36
Ham slicer

**LM00615030**

Coltello pane cm. 30
Ham slicer wavy edge

**LM00630036**

Coltello porchetta cm. 36
Ham slicer

**LM00633020**

Sgorbia prosciutto curva cm. 20
Ham boner

**LM00610026**

Coltello salato cm. 26
Cheese knife

**LM00610032**

Coltello salato cm. 32
Cheese knife

**LM00610036**

Coltello salato - Cheese knife cm. 36



Lame in acciaio inossidabile al cromo - molibdeno - vanadio.
Manico in plastica semirigida antiscivolo (Megol), resistente da -20° a +140°

Chromium molybdenum vanadium stainless steel blades.
No-slip semirigid plastic handle (Megol), resisting the temperature from -20° to +140°

MEGOL
SERIES

**LM00560014**

Coltello scanno cm. 14
Sticking knife

**LM00560016**

Coltello scanno cm. 16
Sticking knife

**LM00560018**

Coltello scanno cm. 18
Sticking knife

**LM00560020**

Coltello scanno cm. 20
Sticking knife

**LM00710025**

Coltello cuoco cm. 25
Cook's knife

**LM00710027**

Coltello cuoco cm. 27
Cook's knife

**LM00710030**

Coltello cuoco cm. 30
Cook's knife

**LM00611025**

Coltello pasta cm. 25
Pasta knife

**LM00917017**

Coltello flessibile per filettare - Fillet knife cm. 17

**LM00551015**

Coltello scuoiare cm. 15
Beef skinner knife

**LM00552027**

Coltello scimitarra cm. 27
Scimitar steak knife

**LM00552032**

Coltello scimitarra cm. 32
Scimitar steak knife



Lame in acciaio inossidabile al cromo - molibdeno - vanadio.
Manico in plastica semirigida antiscivolo (Megol), resistente da -20° a +140°

Chromium molybdenum vanadium stainless steel blades.
No-slip semirigid plastic handle (Megol), resisting the temperature from -20° to +140°

MEGOL
SERIES

7

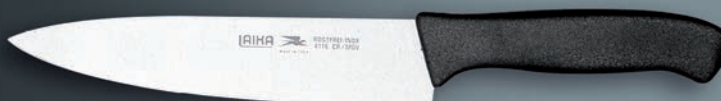
**LE00905007**Coltello verdura - *Peeling knife* cm. 7**LE00907010**Coltello cucina - *Office knife* cm. 10**LE00910011**Coltello tavola - *Universal knife* cm. 11**LE00912011**Coltello costata - *Steak knife* cm. 11**LE00915011**Coltello agrumi - *Tomato knife* cm. 11**LE00916017**Coltello formaggio - *Cheese knife* cm. 17**LE00920016**Coltello cucina - *Kitchen knife* cm. 16**LE00920018**Coltello cucina - *Kitchen knife* cm. 18**LE00920020**Coltello cucina - *Kitchen knife* cm. 20**LE00922018**Coltello santoku - *Santoku knife* cm. 18**LE00925023**Coltello arrosto - *Carving knife* cm. 23**LE00930022**Coltello pane - *Bread knife* cm. 22**LE00935024**Coltello prosciutto - *Ham slicer* cm. 24**LE00938026**Coltello salmone - *Ham slicer with scalloped edge* cm. 26**LE00940024**Coltello da salato - *Cheese knife* cm. 24**LE00945017**Forchettone - *Kitchen fork* cm. 17

Lame in acciaio
inossidabile al
cromo - molibdeno -
vanadio.
Manico in plastica
semirigida
antiscivolo (Isoflex),
resistente in
lavastoviglie

Chromium
molybdenum
vanadium
stainless steel
blades.
No-slip semirigid
plastic handle
(Isoflex), dish-washer
machine resistant

EUROPA
SERIES

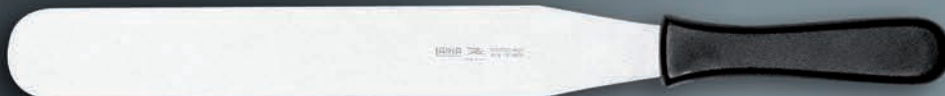
**LE00950024**Mezzaluna - *Mincing knife* cm. 24**LE00955018**Coltello pesto cm. 18
Cleaver**LE00958014**Mannaretta - *Cleaver* cm. 14**LE00958016**Mannaretta - *Cleaver* cm. 16**LE00958020**Mannaretta - *Cleaver* cm. 20**LE00890110**Spatola inox per pizza cm. 10
Triangular spatula**LE00894000**Spatola inox lama diritta - *Palette* cm. 16 • - 22 • - 26 • - 28 • - 30 • - 35 •**LE00895030**Spatola inox lama piegata - *Spatola offset blade* cm. 30**LE00896015**Spatola inox lama piegata - *Turner* cm. 15 x 9**LE00896016**Spatola inox lama piegata - *Turner* cm. 16 x 10**LE00898017**Spatola inox per fritti cm. 17x9
Turner

Lame in acciaio inossidabile al cromo - molibdeno - vanadio.
Manico in plastica semirigida antiscivolo (Isoflex), resistente in lavastoviglie

*Chromium molybdenum vanadium stainless steel blades.
No-slip semirigid plastic handle (Isoflex), dish-washer machine resistant*

- I codici dei pesi e delle misure alternative li troverete sul listino prezzi.

Weight and measure code numbers are available on the price list.

EUROPA

SERIES

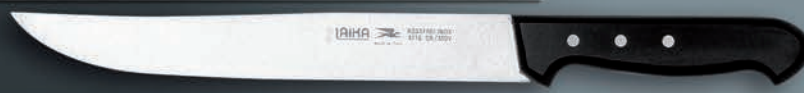
**LP00905007**Coltello verdura - *Peeling knife* cm. 7**LP00907010**Coltello cucina - *Office knife* cm. 10**LP00910011**Coltello tavola - *Universal knife* cm. 11**LP00912011**Coltello costata - *Steak knife* cm. 11**LP00915011**Coltello agrumi - *Tomato knife* cm. 11**LP00916012**Coltello formaggio - *Cheese knife* cm. 12**LP00916017**Coltello formaggio - *Cheese knife* cm. 17**LP00920016**Coltello cucina cm. 16
Kitchen knife**LP00920018**Coltello cucina cm. 18
Kitchen knife**LP00920020**Coltello cucina cm. 20
Kitchen knife**LP00925023**Coltello arrosto cm. 23
Carving knife**LP00930022**Coltello pane cm. 22
Bread knife**LP00935024**Coltello prosciutto cm. 24
Ham slicer**LP00937026**Coltello prosciutto stetto - *Ham slicer* cm. 26**LP00938026**Coltello salmone cm. 26
Ham slicer with scalloped edge**LP00940024**Coltello da salato cm. 24
Cheese knife**LP00945017**Forchettone cm. 17
Kitchen fork**LP00955018**Coltello pesto cm. 18
Cleaver**LP00958014**Mannaretta cm. 14
Cleaver

Lame in acciaio inossidabile al cromo - molibdeno - vanadio. Manico in resina acetica (Pom), con rivetti passanti e rifinito a mano, resistente in lavastoviglie fino a 110°.

Chromium molybdenum vanadium stainless steel blades. Acetal copolymers (Pom) handle with crossing rivets and finished by hand, dish-washer machine resistant to a maximum of 110°.

ELEGANCE

SERIES

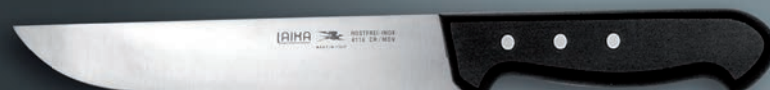
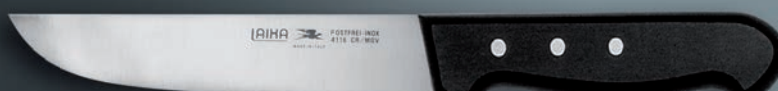
**LP00922014**Coltello santoku - *Santoku knife* cm. 14**LP00922018**Coltello santoku - *Santoku knife* cm. 18**LP00917017**Coltello flessibile per filettare - *Fillet knife* cm. 17**LP00510016**Coltello disosso stretto - *Boning knife* cm. 16**LP00540018**Coltello macellaio - *Butcher's knife* cm. 18**LP00540020**Coltello macellaio - *Butcher's knife* cm. 20**LP00540022**Coltello macellaio - *Butcher's knife* cm. 22**LW00903002**Coltello castagna cm. 2,5
Chestnut knife**LW00905007**Coltello verdura cm. 7 - *Peeling knife***LW00910011**Coltello tavola cm. 11 - *Universal knife***LW00907010**Coltello cucina cm. 10 - *Office knife***LW00912011**Coltello costata cm. 11 - *Steak knife***LW00920000**Coltello cucina cm. 16 - 18 - 20 - *Kitchen knife***LW00925023**Coltello arrosto cm. 23 - *Carving knife***LW00930022**Coltello pane cm. 22 - *Bread knife***LW00935024**Coltello prosciutto cm. 24 - *Ham slicer*

Lame in acciaio inossidabile al cromo - molibdeno - vanadio.
Manico in resina acetica (Pom) o Palissandro, con rivetti passanti e rifinito a mano, resistente in lavastoviglie fino a 110°.

Chromium molybdenum vanadium stainless steel blades.
Acetal copolymers (Pom) or Rosewood handle with crossing rivets and finished by hand, dish-washer machine resistant to a maximum of 110°.

ELEGANCE

SERIES

**EX00413008**

Coltello verdura cm. 8

**EX00411009**

Coltello cucina cm. 9

**EX00411012**

Coltello cucina cm. 12

**EX00415011**

Coltello tavola cm. 11

**EX00414011**

Coltello costata cm. 11

**EX00412013**

Coltello pomodoro cm. 13

**EX00417018**

Forchettone cm. 18

**EX00411013**

Coltello cucina cm. 15

**EX00421015**

Coltello santoku cm. 15

**EX00411020**

Coltello cucina cm. 20

**EX00418022**

Coltello pane cm. 21

**EX00419023**

Coltello arrosto cm. 20



Coltelli forgiati in acciaio inossidabile 420J2. Manico in resina acetilica (Pom), con rivetti passanti e resistente in lavastoviglie fino a 110°.

CHEF'S

SERIES



I coltelli della serie Herne sono prodotti in acciaio di alta qualità (420J2). Il disegno ergonomico del manico garantisce un'ottima presa.

HERNE SERIES



Carl Schmidt Sohn

I coltelli della serie Shikoku sono prodotti in acciaio di alta qualità al cromo-molibdeno-vanadio (8Cr13Mov) per una maggiore resistenza alla corrosione. Dotati di un manico con rivestimento in gomma antiscivolo e lame con alveoli per una grande facilità di taglio. Ideali per aspiranti chef!

SHIKOKU SERIES

CS03808307

Coltello verdura cm. 7



CS03802109

Coltello cucina cm. 9



CS03799414

Coltello disosso cm. 14



CS03805213

Coltello cucina cm. 13



CS03796315

Coltello santoku cm. 15



CS03790120

Coltello arrosto cm. 20



CS03787120

Coltello cucina cm. 20



CS03793221

Coltello pane cm. 21



CS02005709

Coltello cucina cm. 9



CS02008813

Coltello santoku cm. 13



CS02011818

Coltello Tepanyaki cm. 18



CS03924016

Mannaretta cm. 16



CS02002617

Coltello santoku cm. 17



CS02076720

Coltello pane cm. 20



CS01999020

Coltello arrosto cm. 20



L000815005
Coltello assaggio cm. 5



L000815007
Coltello assaggio cm. 7



L000820010
Coltello tipo Pavia, manico plastica cm. 10



L000820012
Coltello tipo Pavia, manico plastica cm. 12



L000825010
Coltello ad uncino, manico plastica cm. 10



L000830014
Coltello tipo Milano, manico plastica cm. 14



L000840014
Coltello tipo Bergamo, manico plastica cm. 14



L000835014
Coltello doppia sega, manico plastica cm. 14



L000880015
Tassello per assaggio, inox, cm. 15



L000845014
Coltello tipo Roma, manico plastica cm. 14



L000850016
Coltello tipo Premana, manico plastica cm. 16



L000855015
Coltello tipo Vercelli, manico plastica cm. 15



L000860014
Coltello tipo Veneto, manico plastica cm. 14x10



L000860016
Coltello tipo Veneto, manico plastica cm. 16x12



L000865013
Coltello tipo Quadro, manico plastica cm. 13x7



L000865017
Coltello tipo Quadro, manico plastica cm. 17x9



PROFESSIONAL
SERIES

**L000800055**

Taglia formaggio inox cm. 55x42

**L052085027**

Taglia formaggio con base in polietilene alimentare H 36 cm x 27 cm

**L000805000**

Confezione da 5 colt. assaggio

**L000882013**

Arco a filo cm. 13

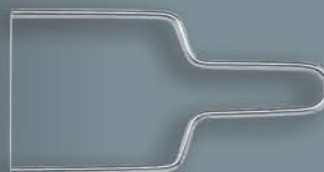
**L000883020**

Coltello per gorgonzola, manico plastica cm. 20

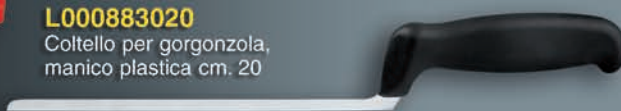
**L000810000**

Confezione da 2 colt. assaggio

**L000868017**

Coltello emmenthal manico plastica cm. 17x17

L000868020

Coltello emmenthal manico plastica cm. 20x20

L000868025

Coltello emmenthal, manico plastica cm. 25x20

**L000881130**

Filo da taglio c/manici cm. 130

L00885040

Coltello formaggio, manico plastica cm. 40

**L000886040**

Coltello a due mani, manico plastica cm. 40

**L000886050**

Coltello a due mani, manico plastica cm. 50

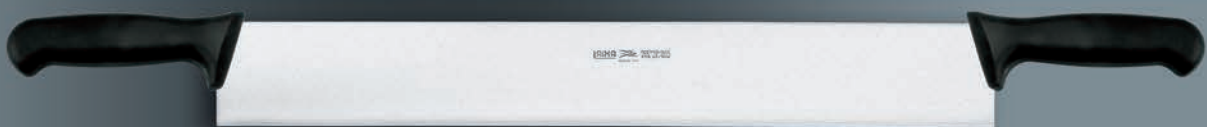

PROFESSIONAL

SERIES

**LX00912015**

Coltello costata forgiato con manico in Cervo cm. 11
Forged steak knife with handle of Stag

**LX00912014**

Coltello costata forgiato con manico in Corno cm. 11
Forged steak knife with handle of Horn

Lame in acciaio inossidabile al cromo - molibdeno - vanadio, interamente forgiate e accuratamente rifinite a mano.

Chromium molybdenum vanadio stainless steel blades, entirely forged and carefully hand finished up.

**C003108003**

Taglia tartufi in olivo e lama inox retta

**C003108001**

Taglia tartufi inox lama retta

**C003108002**

Taglia tartufi inox lama ondulata

L003065002 serie Elegance
L003065003 serie Europa
 Ceppo colt. 6 Pz.
Knife logs 6 Pcs.



L003067002 serie Elegance
L003067003 serie Europa
 Ceppo colt. 8 Pz.
Knife logs 8 Pcs.



L003069002 serie Elegance
L003069003 serie Europa
 Ceppo colt. 13 Pz.
Knife logs 13 Pcs.



Europa



Elegance

EXCLUSIVE
 SERIES

**FU00104009**

Coltello cucina cm. 9

**FU00105015**

Coltello cucina cm. 15

**FU00107025**

Coltello cucina cm. 25

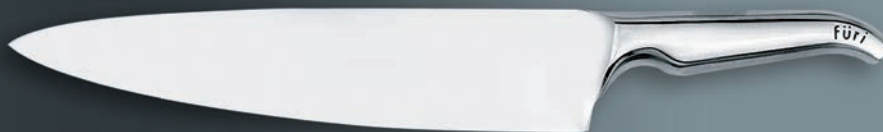
**FU00103025**

Coltello pane cm. 25

**FU00611013**

Coltello disosso cm. 13

**FU00108018**

Coltello filettare cm. 18

**FU00109017**

Forchettone

**KIQ50387**

Affilatrice elettrica KitchenIQ con mole diamantate e parte di rifinitura in ceramica

**KIQ50043**

Affilatoio per coltelli e forbici con impugnatura antiscivolo

**KIQ50044**

Affilatoio per coltelli da posizionare sul bordo dei piani di lavoro

**KIQ50265**

Affilatoio semiprofessionale per coltelli con angolo di affilatura regolabile

**BG00150300**

Valigetta chef in materiale plastico (VUOTA)
 misure interne cm. 48 x 30 x 9,5

**FX00800305**

Borsa per chef in cordura con tracolla

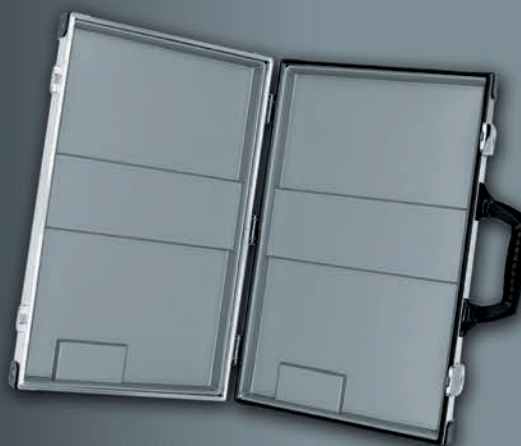
**FX00900015**

Valigetta portacoltelli in alluminio
 con bande magnetiche
 dimensioni interne
 cm. 45 x 27 x 7

**FX00900309**

Trousse per cuochi a 9 posti

FX00900313

Trousse per cuochi a 13 posti

L003064004

Ceppo portacoltelli magnetico
 mod. "Verona" in faggio verniciato
 naturale con foro per acciaino
 cm. 20x12.5x25.5
 lunghezza massima lama cm. 25

**L003064005**

Ceppo portacoltelli magnetico
 mod. "Venezia", composto da 4 elementi
 in faggio verniciato naturale
 cm. 20x12.5x26
 lunghezza massima lama cm. 28



**SB03968013**

Coltello disosso cm. 13

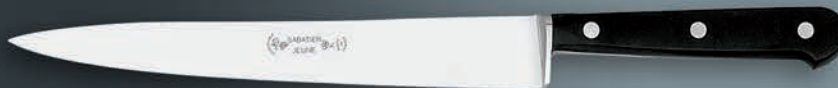
**SB02970017** Coltello filettare cm. 15 - **SB02970020** Coltello filettare cm. 20**SB02935020**

Coltello pane cm. 20

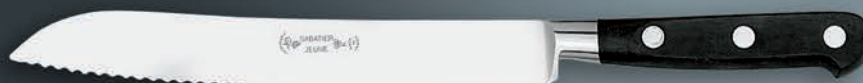
**SB00421020**

Coltello arrosto cm. 20

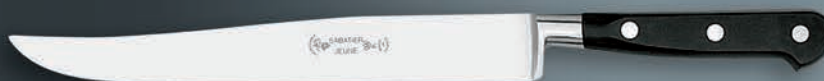
**SB00503017**

Forchettone cm. 17

**SB00501020**

Affilatoio cm. 20

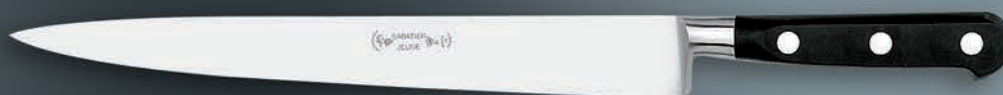
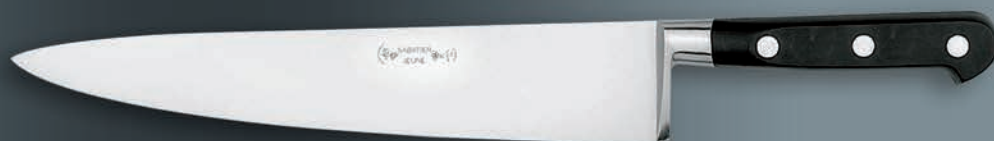
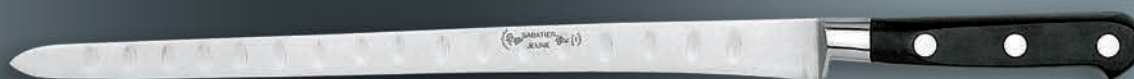
**SB02968020** Coltello trinciante cm. 20 - **SB02968025** Coltello trinciante cm. 25**SB00968010** Coltello cucina cm. 10 - **SB00968015** Coltello cuoco cm. 15**SB00968020** Coltello cuoco cm. 20 - **SB00968025** Coltello cuoco cm. 25**SB00968030** Coltello cuoco cm. 30 - **SB00968035** Coltello cuoco cm. 35**SB01237030**

Coltello salmone cm. 30



BG01025013

Coltello disossare cm. 13

**BG01025016**

Coltello disossare cm. 16

**BG01024017**

Coltello per trippa cm. 17

**BG00246017**

Coltello filettare cm. 17

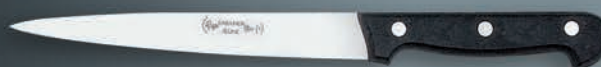
**BG00246020**

Coltello filettare cm. 20

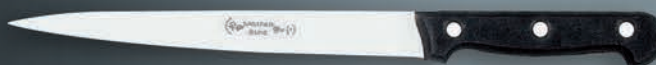
**BG00610030**

Coltello macellaio con alveoli cm. 30

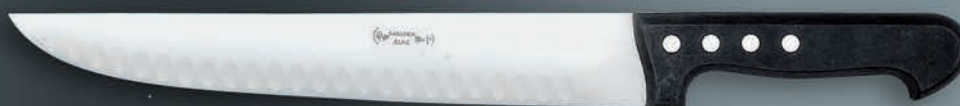
**BG00413035**Coltello per pesce,
dentato cm. 35**BG00413042**Coltello per pesce,
dentato cm. 42



BG00430510
Set di 12 aghi per carne

BG00456510
Ago per carne inox,
curvo cm. 20

BG00455250
Ago per carne inox,
diritto cm. 25



BG00610024
Trinciapollo inox cm. 24



BG00641000
Squamatore



BG00659028
Forbice pesce cm. 28



BG00380500
Pinza spina pesce cm. 11



BG02318009
Squamatore inox cm. 9



BG00490028
Taglia ricci, lame inox cm. 28



BG00412016
Squamatore professionale inox cm. 16

BG00293025
Lardellatore inox cm. 25

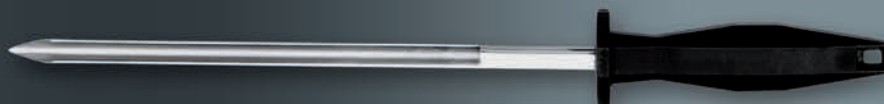

BG04003047
Barra magnetica cm. 47

BG04003034
Barra magnetica cm. 34

VR4057B50

Coltello costata m/co ABS,
lama cm. 11 microdentata - box 50 pezzi

**VR4123NB50**

Coltello tavola m/co ABS,
lama cm. 11,5 microdentata - box 50 pezzi

**VR110**

Coltello costata Laguiole,
tutto inox, lama cm. 11,5 microdentata - box 12 pezzi

**VE706WF/BBP****VE706PR/BBP****VE706TR/BBP**

Ceppi in legno
con 6 steak Laguiole,
m/co ABS,
lama cm. 11,5 microdentata

**VE660060 / BBP**

Ceppo in legno con 6 steak
Laguiole, m/co Ulivo,
lama cm. 11,5 microdentata

**VE7061 / BBP**

Ceppo in legno con 6 steak
Laguiole, m/co ABS OFF WHITE,
lama cm. 11,5 microdentata

**VE65006 / BBP**

Ceppo in legno con 6 steak Laguiole,
m/co in Acrilico mod HAVANE,
lama cm. 11,5 microdentata

**VE6600102090**

Set 3 pezzi per formaggio m/co Ulivo

**VE6500102**

Set 2 pezzi per formaggio mod. HAVANE



André Verdier
COUETELIER FABRICANT
MAISON FONDÉE EN 1859
100% FRANCE

**SPT2468190**

40x165 mm.

SPT2458190

50x85 mm.

SPT2448190

28x110 mm.

SPT2438190

23x90 mm.

Spatole professionali in acciaio temperato in un solo pezzo, finitura professionale, facili da pulire. Disegnate in collaborazione con la famosa chef Anne-Sophie PIC (unica chef donna con 3 stelle Michelin in Francia).

**ECKBC23081**

Set professionale da decoro, lame in acciaio inox temperato, finitura professionale, affilatura tecnica, impugnatura lunga, manico in quercia con trattamento Ecoprocess per resistere all'acqua e all'umidità. Disegnate in collaborazione con la famosa chef Anne-Sophie PIC (unica chef donna con 3 stelle Michelin in Francia).

**7051CD**

Coltello pane con lama cm. 17,5 m/co abs OFF WHITE

**60050CD**

Coltello pane con lama cm. 17,5 m/co in Ulivo

**Laguiole sommeliers CEPAGE PRESTIGE**

Molla finemente incisa, doppia testina in acciaio inox ricavata dal pieno.

CEP15299313 manico Cervo**CEP15299316** manico Corno Biondo**CEP15299301** manico Ulivo**CEP15299311** manico Ebano**CEP15299307** manico Wengé**Laguiole PRESTIGE FORGE'**

Lama in acciaio inox Sandvick da 3 mm. di spessore, molla e mosca forgiati, dorso e mosca incisi, testina in acciaio inox ricavata dal pieno, finitura a mano, misura da chiuso 12 cm. 100% made in France.

8251F12COB manico Corno Biondo**8251F12G** manico Ginepro**8251F12E** manico Ebano**8251F12A** manico Amourette**Laguiole PRESTIGE FORGE' con cavatappi****8252F12COB** manico Corno Biondo**8252F12G** manico Ginepro**8252F12E** manico Ebano**8252F12A** manico Amourette**Laguiole DELUXE**

Lama in acciaio inox Sandvick da 2,5 mm. di spessore, dorso e mosca incisi, testina in acciaio inox ricavata dal pieno, finitura a mano, misura da chiuso 11 cm. 100% made in France.

826111COB manico Corno Biondo**826111G** manico Ginepro**826111P** manico Palissandro**826111O** manico Ulivo**Laguiole DELUXE con cavatappi**

Lama in acciaio inox Sandvick da 2,5 mm. di spessore, dorso e mosca incisi, testina in acciaio inox ricavata dal pieno, finitura a mano, misura da chiuso 11 cm. 100% made in France.

826211COB manico Corno Biondo - **826211G** manico Ginepro**826211P** manico Palissandro - **826211O** manico Ulivo

André Verdier
COUPELIER FABRICANT
MAISON FONDÉE EN 1859
100% FRANCE

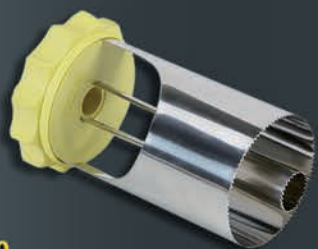
**C003108100**

Sbuccia ananas "Ananissimo" ø mm. 85

**C003179000**

Forbice pesce cm. 19,5

**C003109001**

Pressa hamburger in alluminio ø mm. 90

L002331090

Dischi per hamburger ø mm. 90 confezione da Kg. 1

L002331100

Dischi per hamburger ø mm. 100 confezione da Kg. 1

L002331110

Dischi per hamburger ø mm. 110 confezione da Kg. 1

**C003169000**

Forbice cucina inox smontabile

**C003164000**

Set free-hands "Premax"

**C003162000**

Pelagamberetti inox

**C003160000** - Pinza per aragosta inox
Lobster plier, stainless steel**C003163000** - Forbici per crostacei inox
Lobster shear, stainless steel**C003165000** - Forbici cucina inox smontabile
Fish shear, disassembled, stainless steel**C003167000** - Forbici cucina inox m/co vernicial
Kitchen shear, stainless steel**C003175000** - Trinciapollo gazzella nichelato
*Poultry shear, nickel plated***C003176000**
*inox - stainless steel***C003186000** - Rompinoci inox
Nautcracker, stainless steel**C003180000** - Masticatore curvo cromato
*Chewer, chrome plated***C003181000** - Masticatore curvo inox
Chewer, stainless steel**C003185000**Rompinoci inox forma moderna
Nautcracker, stainless steel

T700151000
Scavino ø mm. 10



T700190000
Scavino ovale



T700151800
Scavino ø mm. 18



T700180000
Scavino ovale



T700152500
Scavino ø mm. 25



T700900400
Riga limone



T700153000
Scavino ø mm. 30



T700950400
Decoratore



T10020300
Scavino doppio ø mm. 22/30



T700250600
Coltello per arancia



T700051600
Levator solo



T700850300
Forchetta per patate



T700400600
Pelapatate



T100550500
Leva capsule



T101871100
Pela asparagi



T700520800
Pelapatate



T701100800
Arricciaburro



T700301000
Coltello per pompelmo



T700121000
Decoratore per frutta



T504861302
Pinza spina pesce inox mm. 130



T705230900 Spatola piegata cm. 9



T705191200 Spatola diritta cm. 12





T101830900
Coltello decoratore



T700960300
Coltello decoratore



T101840900
Coltello decoratore

FX00506900

Pela pomodoro "Castor",
lama micro dentata



T700700500
Rotella tagliapasta
ø mm. 50



FX00505901

Taglia julienne ad archetto
inox "Castor"



T700700700
Rotella tagliapasta
ø mm. 70



FX00505900

Pelapatate ad archetto
inox "Castor"

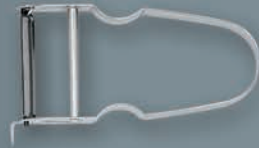

T500540000

Pelapatate ad archetto
ABS



T505771007
Rotella tagliapizza
ø mm. 100



T701250900
Frusta mm. 85

T701411502
Taglia tartufo



T701281300
Frusta mm. 130



T701281700
Frusta mm. 170



T42211402
Mezzaluna mm. 140
T422211802
Mezzaluna mm. 180
T422312302
Mezzaluna mm. 230



T701341800
Paletta per antiaderente
mm. 180



T422121402
Mezzaluna doppia mm. 140
T422221802
Mezzaluna doppia mm. 180
T422322302
Mezzaluna doppia mm. 230

**T504702400**

Pinza inox per cucina cm. 24

T504703800

Pinza inox per cucina cm. 38

T704811202

Squamatore con lama intercambiabile

**T504911102**

Forbice per pizza smontabile

**T701191100**

Affetta formaggio

**T700931202**

Coltello per Julienne

**T758455000**

Coltello decoratore

**T700940302**Set per julienne
completo di 3 lame
mm. 3-6-45**T504300002**

Radish curler

T501000502

Spiral cutter

**T504362200** Potato spiral**T501861802**

Pela asparagi



T542040700
Coltello per ostriche



T542010600
Coltello per ostriche
m/co legno



T542020002
Coltello per ostriche
m/co ABS



T542000102
Coltello per ostriche m/co POM



T504871500
Pinza dritta cm. 15



T504881500
Pinza becchi piegati cm. 15



T504982000
Pinza a ginocchio cm. 20

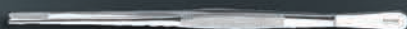

T504872000
Pinza dritta cm. 20



T504873000
Pinza dritta cm. 30



T710137710
Cucchiaio artistico
per decorazioni



T504780902
Forbici per erbe



T504871500
Pinza dritta cm. 15



T504881500
Pinza becchi piegati cm. 15



T504982000
Pinza a ginocchio cm. 20



T504872000
Pinza dritta cm. 20



T504873000
Pinza dritta cm. 30



T710137710
Cucchiaio artistico
per decorazioni



T501996502
Sfilettatore per
piccoli pesci





T582500202 Trita erbe aromatiche

T720170400
Coltello decoratore



T720924502
Svuota verdure



T258115000
Decoratore



T258105000
Decoratore



T258135000
Decoratore



T258145000
Decoratore



T258125000
Decoratore



T256605000
Coltello per intagliare



T266610202
Coltello thai 2 lame

T266625002
Coltello thai lama fissa

T258154600
Scavino



T258174500
Affilatoio ceramico



T909050602 Set decoro 6 pezzi
"Villafane studios"



T908440802 Set decoro 8 pezzi



T908582002
Set decoro 20 pezzi



T908180802
Set per decorare, completo di 8 pezzi



4100CLR Rouet Gourmet

Taglia vegetali e frutt in sottili strisce o fette in continuo. Struttura in acciaio inossidabile con 4 piedini a ventosa. Inclusi 3 set di lame.



100RP Grattuggia per Muesli

Interamente in acciaio inox. La sicurezza delle dita è garantita dalla speciale affilatura degli incavi. Dimensioni mm. 280x120x15

TU01 Turn'up

Coppette di verdura in pochi minuti! Struttura in fibra e lame, smontabili, in acciaio inox. Diametro lama cm. 5



1010CT Tagliatartufo Professionale

Fette perfette grazie alla lama in acciaio temperato con speciale taglio a rasoio. Regolazione dello spessore da mm. 0,1 a 4. Massiccia struttura in acciaio inox, fornito in cofanetto di legno.



403C210 Taglia Patate

Struttura in acciaio nichelato e lame in acciaio inox a doppia affilatura da mm. 10, blocco a pressare in resina sintetica.



RTF01B Grattuggia Tartufo

Interamente in acciaio inox, fornita con cofanetto di legno.



300RP Grattuggia Fine

Per grattugiare finemente patate fresche, parmigiano, limoni, aglio, mele, ecc. La sicurezza delle dita è garantita dalla speciale affilatura degli incavi. Grande struttura in acciaio inox con piedini antiscivolo. Dimensioni mm. 135x400x240

BREZ01 CE

Set per raclette con supporto per formaggio amovibile e lavabile in lavastoviglie 230 V - 1000 W



15000

Mandolina inox originale "Bron-coucke", completa di 4 blocchi di lame intercambiabili da mm. 2 / 4 / 7 / 10. Dimensioni mm. 115x400x40 / 1,500 Kg.



8486JAPP - 8485JAPG

Mandolina giapponese originale Benriner®
8486JAPP larghezza mm 65
8485JAPG larghezza mm 95
includi 3 lame intercambiabili

**ST00050797**

Coltello in acciaio ad alto tenore di carbonio con rivestimento al teflon, manico antibatterico in microban, lama 20 cm.

**ST00050547**

Coltello in acciaio ad alto tenore di carbonio con rivestimento al teflon, manico antibatterico in microban, lama 20 cm.

**ST00050546**

Coltello in acciaio ad alto tenore di carbonio con rivestimento al teflon, manico antibatterico in microban, lama 21 cm.

**ST00050544**

Coltello in acciaio ad alto tenore di carbonio con rivestimento al teflon, manico antibatterico in microban, lama 18 cm.

**ST00050543**

Coltello in acciaio ad alto tenore di carbonio con rivestimento al teflon, manico antibatterico in microban, lama 13 cm.

**ST00050542**

Coltello in acciaio ad alto tenore di carbonio con rivestimento al teflon, manico antibatterico in microban, lama 8,5 cm.

**ST00050498**

Ceppo universale per coltelli, interno removibile e lavabile in lavastoviglie.

**ST00016002**

Forbice sminuzza erbe a 5 lame, manico confortevole con rivestimento in gomma e accessorio per una facile pulizia.

**ST00052894**

Spazzola in metallo per grill 7 x 8 x 44 cm.

ST00052898

Spazzola in metallo per grill 28 x 16 cm.

**ST00051450**

Guanto anticalore per griglia

ST00052897

Pinza per grill 34 cm.

**ST00052899**

Pennello per marinare cm. 39 x 1,5

**ST00050539**

Coltello in acciaio ad alto tenore di carbonio con rivestimento al titanio, manico antibatterico in microban, lama 17,5 cm.

**ST00050537**

Coltello in acciaio ad alto tenore di carbonio con rivestimento al titanio, manico antibatterico in microban, lama 13 cm.

**ST00051438**

Set per griglia composto da 3 pezzi, cm. 45

**ST00050504**

Coltello in acciaio damascato 67 strati, m/co soft-touch, lama 19,5 cm.

**ST00050503**

Coltello in acciaio damascato 67 strati, m/co soft-touch, lama 16 cm.

**ST00050502**

Coltello in acciaio damascato 67 strati, m/co soft-touch, lama 12,5 cm.

**ST00050501**

Coltello in acciaio damascato 67 strati, m/co soft-touch, lama 8,5 cm.

**ST00050324**

Coltello in ceramica, m/co soft-touch, lama 14,5 cm.

**ST00050323**

Coltello in ceramica, m/co soft-touch, lama 15 cm.

**ST00050326**

Coltello in ceramica, m/co soft-touch, lama 12,5 cm.

**ST00050327**

Coltello in ceramica, m/co soft-touch, lama 10 cm.

**ST00050328**

Coltello in ceramica, m/co soft-touch, lama 7,5 cm.

**ST00051932**

Pelapatate con lama in ceramica.

**ST00050097**

Bruciatore per flambe.

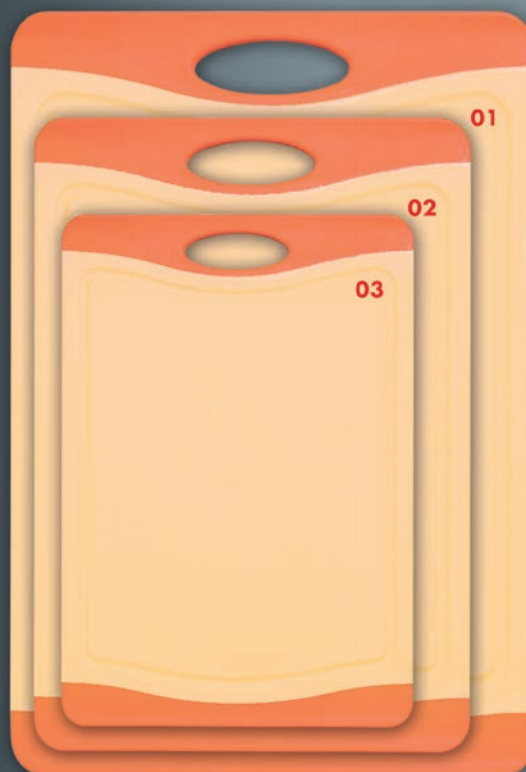
**01. ST00050525**

Tagliere antibatterico con tecnologia microban 44,5 x 30,5 cm.

02. ST00050526

Tagliere antibatterico con tecnologia microban 36,8 x 25,4 cm.

03. ST00050527

Tagliere antibatterico con tecnologia microban 29,2 x 20,3 cm.

Tutti gli articoli
Gastromax®
resistono a
temperature
fino a 265°C ove
diversamente
indicato

GS00313100
Sbattitore



GS00330100
Schiacciapatate



GS00341000
Spalmaburro



GS00319000
Raschietto



GS00340100
Porzionatore per gelato



GS00319800
Leccapentole 125°



GS00669000
Sminuzza cipolle,
aglio, chilli etc...



GS00669500
Mandolina



GS00668500
Tagliaverdure



GS00660100
Schiacciapatate completo di differenti griglie



GS00660200
Grattugia universale "Gastromax"
completa di due lame



GS00476300
"Pot Clip" reggi mestolo
silicone/acciaio inox
Resistente fino a 315° C
Espositore 12 pezzi



Tutti gli articoli
Gastromax®
resistono a
temperature
fino a 265°C ove
diversamente
indicato

GS00364000
Coltello per dolci



GS00313600
Forchettone



GS00314100
Cucchiaino 1/2 dl



GS00320100
Schiumarola



GS00316200
Cucchiaino per spaghetti



GS00345100
Coltello per formaggio



GS00318600
Mestolo 1 dl



GS00652600
Paletta per fritti



GS00310300
Paletta



GS00681600
Frusta professionale



GS00682300

Cucchiaino professionale da chef, lunghezza cm. 34



GS00314600 Pinza per cucina mm. 290
GS00314700 Pinza da portata mm. 183



GS00681400
Paletta professionale da chef, lunghezza cm. 34



GS00653500
Pinza per cucina a becchi larghi mm. 280



GS00681200
Schiumarola professionale da chef, lunghezza cm. 36,5



GS00682000
Pinza professionale da chef,
lunghezza cm. 31 ideale per cibi molto delicati



GS00682400
Set da servizio professionale



ORIGINAL
GastroMaxTM

**GS00653700**

Pennello in silicone
larghezza mm. 45

**GS00317200**

Pennello per griglia
mm. 40 - 170°

**GS00653800**

Pennello in silicone
larghezza mm. 20

**GS00317600**

Pennello per pasticceria
mm. 20 - 170°

**GS00848266**

Display utensili professionali
da cucina 48 pezzi

**GS00669600**

Termometro da cucina
con sonda e App per
smartphone

**GS00675200**

Termometro con clip

**GS00848269**

Display utensili professionali
da cucina 138 pezzi

**GS00675300**

Set termometri per carne

**GS00675100**

Termometro per cottura

**EB250402**

Tagliere eco-boards
mod. Classic M - cm. 35x25x2,5

**EB250401**

Tagliere eco-boards
mod. Classic S - cm. 30x20x2,5

**EB250302**

Tagliere eco-boards
mod. Basic A - cm. 35x25x2,5

**EB250301**

Tagliere eco-boards
mod. Basic XS - cm. 30x20x2,5

**EB250307**

Tagliere eco-boards
mod. Professional F - cm. 50x40x2,5

eco boards

Taglieri in legno
di Canfora-Alloro,
con azione naturale
antimicrobica
permanente,
3 volte più igienico
di vetro e plastica





H. 155 mm

TG11680(P) • TG11681(S)Opera pepe e sale in faggio anticato
Scatola regalo

H. 240 mm

TG11682(P) • TG11683(S)Opera pepe e sale in faggio anticato
Scatola regalo

H. 150 mm

TG11350(P) • TG11351(S)

Copenhagen pepe e sale faggio



H. 205 mm

TG11654(P) • TG11655(S)

Oblique pepe e sale noce



H. 125 mm

TG11410(P) • TG11411(S)

Milano pepe e sale in olivo



H. 150 mm

TG11414(P) • TG11415(S)

Lucca pepe e sale in olivo



H. 150 mm

TG11526(P) • TG11527(S)

Classic pepe e sale



H. 200 mm

TG11530(P) • TG11531(S)

Stockholm pepe e sale



H. 200 mm

TG11744(P) • TG11745(S)

Stockholm pepe e sale acrilico/inox



H. 150 mm

TG11715(P) • TG11716(S)

Apollo inox satinato



H. 150 mm

TG11717(P) • TG11718(S)

Apollo acrilico/inox satinato



H. 200 mm

TG11726(P) • TG11727(S)

Sorcerers acrilico/inox satinato

CrushGrind®
The World's **BEST** Mills!



T&G utilizza per i suoi prodotti i meccanismi in ceramica della Danese CrushGrind, probabilmente tra i migliori al mondo.

Le macine sono completamente regolabili dal fine al grossolano con oltre 12 posizioni fisse.

Facili da riempire grazie all'assenza del perno centrale.



H. 175 mm

TG11300(P) • TG11301(S)
Luna pepe e sale



H. 175 mm

TG11302(P) • TG11303(S)
Luna pepe e sale



H. 175 mm

TG11304(P) • TG11305(S)
Luna pepe e sale



H. 175 mm

TG11306(P) • TG11307(S)
Luna pepe e sale



H. 125 mm

TG11120(P) • TG11121(S)
Sole pepe e sale



H. 125 mm

TG11122(P) • TG11123(S)
Sole pepe e sale



H. 125 mm

TG11124(P) • TG11125(S)
Sole pepe e sale



H. 125 mm

TG11126(P) • TG11127(S)
Sole pepe e sale



H. 125 mm

TG11094(P) • TG11095(S)
Tip Top pepe e sale vetro/inox



H. 125 mm

TG11090(P) • TG11091(S)
Tip Top pepe e sale vetro



H. 140 mm

TG11312(P) • TG11313(S)
Capstan pepe e sale acrilico



TG11950
Tip Top set regalo sale/pepe



TG11951
Tip Top set regalo sale/pepe



TG27050
Cassetta porta pepe e sale in acacia
160x90x50 mm.

CrushGrind®
The World's **BEST** Mills!





TG11100
Trita spezie



TG11101
Trita spezie



TG11102
Trita spezie



TG11103
Trita spezie



TG11200
Display Trita spezie 6+6 pezzi



TG11203
Display Trita spezie 6+6 pezzi



TG11083 · TG11087
Trita spezie



H. 410 mm



TG11642(P) · TG11608(P)
Capstan pepe H 410 mm.



TG11684(P)
Opera pepe in faggio anticato H 395



H. 510 mm



TG11646(P) · TG11610(P)
Capstan pepe H 510 mm.

CrushGrind®
The World's **BEST** Mills!





H. 150 mm

TG12902(P) · TG12903(S)

Globe small pepe e sale in acrilico / rame



H. 200 mm

TG12904(P) · TG12905(S)

Globe large pepe e sale in acrilico / rame



H. 180 mm

TG12922(P) · TG12923(S)

Pebble pepe e sale in acrilico / faggio



H. 100 mm

TG12651(P) · TG12652(S)

Capstan pepe e sale in acrilico



H. 145 mm

TG12607(P) · TG12608(S)

Capstan pepe e sale in acrilico



H. 140 mm

TG12648

Bellied combi 2 in 1 pepe e sale in acrilico



H. 92 mm

TG13502

Contenitore sale e pepe in vetro e acciaio inox



H. 96 mm

TG13122

Contenitore sale e pepe in vetro e finiture rame



H. 120 mm

TG12660

Macina noce moscata

**TG12700**

Dispaly con 12 basi per macina sale e pepe in acrilico 155x88x12 mm.

**TG12701**

Dispaly con 12 basi per macina sale e pepe in hevea 160x90x15 mm.

**TG12702**

Dispaly con 12 basi per macina sale e pepe in acacia 160x90x15 mm.

Classic Mills!



**C003142000**

Apriscatole da banco
lunghezza asta cm 50
Table mounted
can opener

**C003100000**

Levatappi automatico
da parete
Wall mounted
cork screw

**C003105000**

Levatappi automatico
da banco con morsetto
Table mounted
cork screw

C003091002

Morsa per mortadella Bologna in acciaio inox - base marmo
Mortadella press, stainless steel, marble base

**C003090003**

Morsa per prosciutto in acciaio inox,
modello lux base in polietilene
Ham press, stainless steel with polyethylene base

C003090000

Morsa per prosciutto in acciaio inox, modello lux
Ham press, stainless steel

**C003090002**

Morsa per prosciutto in acciaio inox, modello lux, base marmo
Ham press, stainless steel, marble base

**C003085000**

Apriostriche inox, con base in legno
Oyster opener, stainless steel



PROFESSIONAL
SERIES



L002059002 - Fenditoio a due mani, acciaio comune, m/co ABS
Cleaver, carbon steel

L002059003 - Fenditoio a due mani, inox, m/co ABS
Cleaver, stainless steel

Peso medio / *Medium weight*: kg. 3,400



L002055002 - Mannaia tipo Emilia, acciaio comune, m/co ABS
Cleaver, carbon steel

L002055003 - Mannaia tipo Emilia, inox, m/co ABS
Cleaver, stainless steel

Peso medio / *Medium weight*: kg. 2,500



L002058002 - Mannaia tipo Genova, acciaio comune, m/co ABS
Cleaver, carbon steel

L002058003 - Mannaia tipo Genova, inox, m/co ABS
Cleaver, stainless steel

Peso medio / *Medium weight*: kg. 3,000



L002060002 - Spadino Roma a due mani, acciaio comune, m/co ABS
Cleaver, carbon steel

L002060003 - Spadino Roma a due mani, inox, m/co ABS
Cleaver, stainless steel

Peso medio / *Medium weight*: kg. 2,700

**L002064002**

Falcetta genovese,
acciaio comune, m/co ABS
Cleaver, carbon steel

L002064003

Falcetta genovese,
inox, m/co ABS
Cleaver, stainless steel

Peso medio

Medium weight: kg. 1,500

**L002066002**

Spadino tipo Roma,
acciaio comune, m/co ABS
Cleaver, carbon steel

L002066003

Spadino tipo Roma,
inox, m/co ABS
Cleaver, stainless steel

Peso medio

Medium weight: kg. 1,300

**L002069023**

Falcetta macello,
inox, m/co ABS cm. 23
Cleaver, carbon steel

L002069026

Falcetta macello,
inox, m/co ABS cm. 26
Cleaver, stainless steel

**L002068000**

Falcetta milanese,
acciaio comune, m/co ABS
disponibile in cm. 20 • - 22 • - 25 •
Cleaver, carbon steel

L002070000

Falcetta milanese,
inox, m/co ABS
disponibile in cm. 20 • - 22 • - 25 •
Cleaver, stainless steel

**L002072001**

Coltello mezzo colpo,
m/co plastica cm. 28 - kg. 0,800
Cleaver, stainless steel

L002072002

Coltello colpo,
m/co plastica cm. 28 - kg. 1,100
Cleaver, stainless steel



• I codici dei pesi e delle misure alternative li troverete sul listino prezzi.

Weight and measure code numbers are available on the price list.

PROFESSIONAL
SERIES

**L002076000**

Gancio inox portasalsiccie
mm. 320 x 6
*Revoling sausage-hanger,
stainless steel*

L002074120

Batticarne inox forgiato
disponibile in Kg. 1,750
Forged tenderizer, stainless steel

**L002078000**

Gancio inox girevole
a una punta
mm. 220 x 9 •
mm. 240 x 10 •
mm. 280 x 12 •
*Revoling hooks
stainless steel*

L002074200

Batticarne inox
disponibile in kg. 1 • - 1,5 • - 2 •
Tenderizer, stainless steel

**L002080000**

Gancio inox portapancetta
mm. 240 x 6
*Bacon hooks,
stainless steel*

L002081000

Pinza inox per affettati
Tongs for sliced charcuterie, stainless steel

**L002082000**

Gancio inox
a esse una punta
mm. 60 x 3 •
mm. 80 x 4 •
mm. 100 x 4 •
mm. 120 x 5 •
mm. 140 x 6 •
mm. 160 x 6 •
mm. 180 x 6 •
mm. 200 x 9 •
*One point
fixed hooks,
stainless steel*

**L002075100**

Batticarne inox forgiato a paletta kg. 1,100
Forged cutlet bat, stainless steel

**L002084000**

Gancio inox ad ancora
a una punta
mm. 120 x 6 •
mm. 130 x 7 •
*One point
anchor hooks,
stainless steel*

**L002075200**

Batticarne inox forgiato a doppio taglio kg. 1,100
Forged cutlet bat, stainless steel

PROFESSIONAL
SERIES

• I codici dei pesi e delle misure alternative li troverete sul listino prezzi.

Weight and measure code numbers are available on the price list.

**1 L021310000**

Anelli segaossa, dentatura spaziata, punte temperate, altezza mm. 20
Blades for endless saw with spaced tooth pattern, hardened tips width mm. 20

2 L021311000

Anelli segaossa, dentatura spaziata, punte temperate, altezza mm. 16
Blades for endless saw with spaced tooth pattern, hardened tips width mm. 16

3 L002134000

Anelli segaossa, dentatura alternata, punte temperate, altezza mm. 20
Blade for endless saw with alternate tooth pattern, hardened tips, Width mm. 20

4 L002134100

Anelli segaossa, dentatura alternata, punte temperate, altezza mm. 16
Blade for endless saw with alternate tooth pattern, hardened tips, Width mm. 16

5 L021321000

Anelli segaossa, speciale per surgelati, dentatura spaziata, punte temperate, altezza mm. 16
Blades for endless saw with spaced tooth pattern, hardened tips width mm. 16

6 L021330000

Anelli segaossa, in acciaio inox, dentatura spaziata, altezza mm. 20
Stainless steel blades for endless saw with spaced tooth pattern, width mm. 20

7 L021331000

Anelli segaossa, in acciaio inox, dentatura spaziata, altezza mm. 16
Stainless steel blades for endless saw with spaced tooth pattern, width mm. 16

- I codici dei pesi e delle misure alternative li troverete sul listino prezzi.

Weight and measure code numbers are available on the price list.

L002135000

Sega da macellaio in acciaio comune
Butcher's saw, carbon steel
disponibili in cm. 40 • - 45 • - 50 • - 60 •

**L002141000**

Lame ricambio in acciaio comune
Spare blade, carbon steel
disponibili in cm. 40 • - 45 • - 50 • - 60 •

L002138000

Sega da macellaio in acciaio inox, a carica rapida,
Butcher's saw, rapid clamping, stainless steel
disponibile in cm. 45 • - 50 •

**L002142000**

Lame ricambio in acciaio inox, a carica rapida
Spare blade, stainless steel
disponibili in cm. 45 • - 50 •

L002136000

Sega da macellaio in acciaio inox
Butcher's saw, stainless steel
disponibili in cm. 40 • - 45 • - 50 • - 60 •

**L002140000**

Lame ricambio in acciaio inox
Spare blade, stainless steel
disponibili in cm. 40 • - 45 • - 50 • - 60 •

L002139000

Sega da macellaio in acciaio inox, a carica rapida, da cm. 50
Butcher's saw, rapid clamping, stainless steel



PROFESSIONAL
SERIES

L216000000

Piastre per tritacarne inox
mod. 5 • - 8 • - 12 • - 22 • - 32 • - 42 •
fori da mm. 2 > 20

Plates for meat mincer, stainless steel

L216100000

Coltelli per tritacarne inox
mod. 5 • - 8 • - 12 • - 22 • - 32 • - 42 •

Knives for meat mincer, stainless steel

**L216000300**

Piastre per tritacarne inox a tre fori
mod. 22 • - 32 • - 42 •

Plates for meat mincer, stainless steel

**L216200000**

Piastre per tritacarne in acciaio al carbonio
mod. 8 • - 12 • - 22 • - 32 • - 42 •

fori da mm. 2 > 20

Plates for meat mincer, carbon steel

L216300000

Coltelli per tritacarne in acciaio al carbonio
mod. 8 • - 12 • - 22 • - 32 • - 42 •

Knives for meat mincer, carbon steel

**L002097000**

Pungisalame m/co plastica,
punte inox

*Sausage prickers,
plastic handle,
stainless steel points*

**BG00288048**

Inteneritrice manuale
originale "Jaccard" a 48 lame

**L002098000**

Abbattibuoi bicalibro 22/380
Knocker double caliber

**L002275028**

Sterilizzatore per
coltelli a norme CE
mm. 280x120 h. 400
*Knife steriliser,
CE approved*

**L002275128**

Sterilizzatore per
coltelli, coibentato,
a norme CE
mm. 280x120 h. 400
*Knife steriliser with
isolated body,
CE approved*

L002275240

Sterilizzatore per
coltelli a raggi
ultavioletti UVC
germicida a
norme CE mm.
400x140 h. 620 -
n°1 lampada UVC
16W - capacità 14
coltelli.
*Knife steriliser at
UVC ultraviolet
rays, CE
approved.*



**TS01854400**

Inteneritrice idraulica con struttura in acciaio inox. Blocco lame composto da 544 punte, massimo spessore della carne da intenerire cm. 12,5 e una larghezza di cm. 30. Colpi al minuto 55 - trifase 380V

**TS01554401**

Inteneritrice manuale da pavimento con struttura in acciaio inox. Blocco lame composto da 544 punte. Spessore massimo della carne da intenerire cm. 12,5 ed una larghezza di cm 30.

**TS01554400**

Inteneritrice manuale da tavolo con struttura in acciaio inox. Blocco lame composto da 544 punte. Spessore massimo della carne da intenerire cm. 12,5 ed una larghezza di cm 30.

**TS01954000**

Inteneritrice elettrica semiautomatica con struttura in acciaio inox. Blocco lame composto da 540 punte. Dimensione massima della carne da intenerire cm. 50 x 40 ed uno spessore massimo di cm. 14. Trifase 380V

**TS01654401**

Inteneritrice manuale da pavimento con struttura in polietilene e inox. Blocco lame composto da 544 punte. Spessore massimo della carne da intenerire cm. 12,5 ed una larghezza di cm 30.

**TS01654400**

Inteneritrice manuale da tavolo con struttura in polietilene e inox. Blocco lame composto da 544 punte. Spessore massimo della carne da intenerire cm. 12,5 ed una larghezza di cm 30.

**L002270000**

Mototritacarne elettrico mod. 22
monofase 220 V 0,80 HP - produzione oraria
130/150 kg. - a norme CE. *Electric meat mincer*

L002271000

Mototritacarne elettrico mod. 32
monofase 220 V 1,5 HP
produzione oraria 160/180 kg.
a norme CE
Electric meat mincer

**L002272002**

Mototritacarne elettrico mod. 32
tramoggia inox - corpo tritacarne
in acciaio inox - motore HP 1,5
monofase 220 V - produzione oraria
400 kg - a norme CE.
Electric meat mincer all stainless steel

L002272001

Mototritacarne elettrico mod. 32 - tramoggia inox
corpo tritacarne in ghisa motore HP 1,5
monofase 220 V - produzione oraria 400 kg. a norme CE.
Electric meat mincer all stainless steel

**L002272003**

Mototritacarne elettrico
mod. 32 - tramoggia e carenatura
motore in acciaio inox - corpo tritacarne in acciaio inox - motore
HP 1,5 - monofase 220 V - produzione oraria 400 kg. - a norme CE
Electric meat mincer all stainless steel

L002283013

Grattugia elettrica in fusione d'alluminio
W 260 - dimensioni cm. 17x29x (H) 27
Peso kg. 8,200 - monofase 220V
a norme CE
Electric grater

**L002281160**

Segaossa elettrico mod. Professional - corpo in alluminio
anodizzato - piano di appoggio in acciaio inox - lama
mm. 1550 - motore HP 1 - monofase 220 V - altezza taglio
mm. 260 - a norme CE
Electric bone saw

**L002282160**

Segaossa elettrico mod. Export - corpo in alluminio
tropicalizzato - piano di appoggio in acciaio inox - lama
mm. 1550 - motore HP 1 - monofase 220 V - altezza taglio
mm. 260 - solo per esportazione in Paesi extra CE
Electric bone saw

L002281184

Segaossa elettrico mod. Professional - corpo in alluminio
anodizzato - piano di appoggio in acciaio inox - lama
mm. 1830 - motore HP 1,5 - monofase 220 V - altezza taglio
mm. 320 - a norme CE
Electric bone saw

L002282184

Segaossa elettrico mod. Export - corpo in alluminio
tropicalizzato - piano di appoggio in acciaio inox - lama
mm. 1840 - motore HP 1,5 - monofase 220 V - altezza taglio
mm. 320 - solo per esportazione in Paesi extra CE
Electric bone saw

**L00664060**

Confezionatrice sottovuoto mod. "Economy" -
potenza 120W - capacità di aspirazione 11 lt/min -
monofase 220V - barra saldante cm. 31 - a norme CE

**L00664040**

Confezionatrice sottovuoto mod. "Basic" -
potenza 120W - capacità di aspirazione 11 lt/min -
monofase 220V - barra saldante cm. 31 - a norme CE

**L00667840**

Macchina per la cottura Sous-Vide - potenza 620W -
dimensioni mm. 420x280x290 - temperatura regolabile
da 5°C a 99°C - timer 99h - monofase 220V - a norme CE

**L00663322**

Segaossa elettrico - corpo e piano appoggio
In acciaio inox - lama mm. 1720 - motore HP 1,5 -
monofase 220V - altezza taglio mm. 250 - a norme CE

**L00664340**

Confezionatrice sottovuoto a campana - potenza 750W -
capacità di aspirazione 10m³/h - dimensioni camera
mm. 385x280x50 - barra saldante cm. 26 - a norme CE

L006651150

Insacatrice litri 3 fiancate verniciate
2 velocità - Set imbuto in plastica

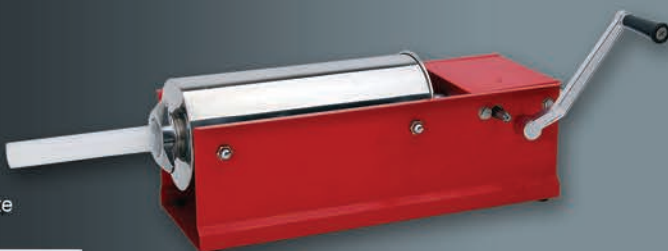
**L006651250**

Insacatrice litri 5 fiancate verniciate
2 velocità - Set imbuto in plastica

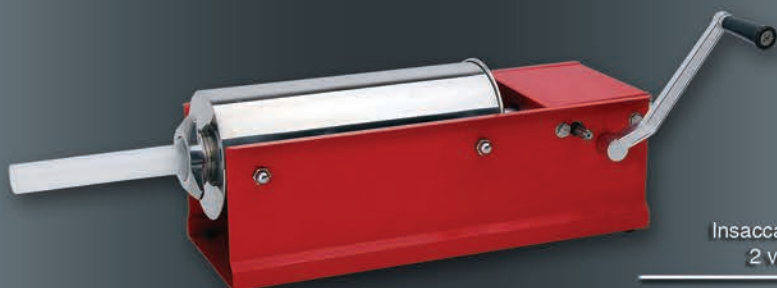
**L006651700**

Insacatrice litri 5 inox
2 velocità - Set imbuto inox

**L006651800**

Insacatrice litri 7 inox
2 velocità - Set imbuto inox

**L006650300**

Insacatrice verticale litri 10 inox
2 velocità - Set imbuto inox

**L006650500**

Insacatrice verticale litri 15 inox
2 velocità - Set imbuto inox



PROFESSIONAL
SERIES

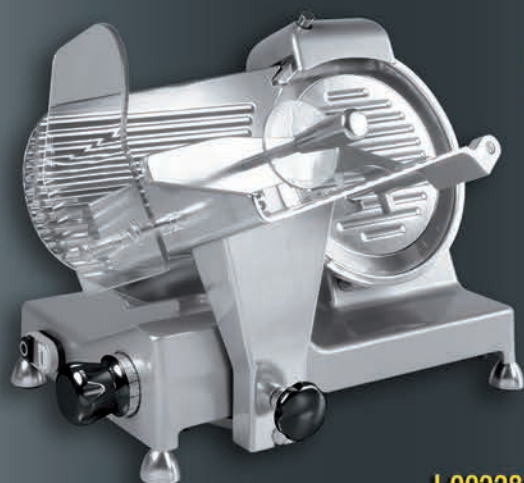

L00225500
Hamburgatrice manuale
ø 100mm. • - 130mm. •



L002284022

Affettatrice elettrica in alluminio pressofuso verniciato
lama mm. 220 - monofase 220V - CE Professionale

L002284025

Affettatrice elettrica in alluminio pressofuso verniciato
lama mm. 250 - monofase 220V - CE Professionale

• I codici dei pesi e delle misure alternative li troverete sul listino prezzi.

Weight and measure code numbers are available on the price list.

W9750

Westmark No. 5



W9752

Westmark No. 8



W9754

Westmark No. 10



Coltelli Westmark in carbonio per tritacarne:

W1485

Mod. 5

W1486

Mod. 8

W1487

Mod. 10

Piastre Westmark in carbonio per tritacarne:

W1476

5 foro 4,5

W1479

5 foro 6

W1482

5 foro 8

W1477

8 foro 4,5

W1480

8 foro 6

W1483

8 foro 8

W1478

10 foro 4,5

W1481

10 foro 6

W1484

10 foro 8

Serie imbusti Westmark:

W1493

Mod. 5

W1494

Mod. 8

W1495

Mod. 10



P003295080

Gabbia in acciaio inox per lavaggio coltelli
A 8 posti + 1 affilatoio



P003295512

Gabbia in acciaio inox per lavaggio coltelli
A 12 posti + 2 affilatoi

PROFESSIONAL
SERIES

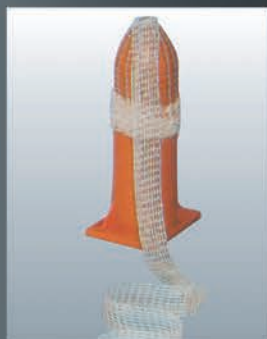
**L002310000**

Tubi completi di ogiva per
caricamento rete.
Diametro mm. 86-96-110-125-140

L002315000
Rete per salumi quadri 10-12-14-16-18

L002316000
Rete per arrosti quadri 10-12-14-16-18

L002317000
Rete pesante per salumi
bianca/rossa quadri 14-16-18-20-22

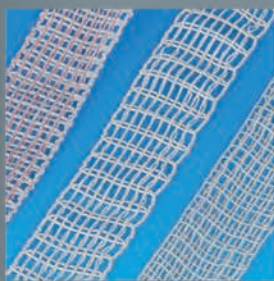
**L002321085**

Spago per arrosti
da 2.4, in rotoli da 85g.
Confezione 10 pezzi

**C006851530**

Buste goffrate per sottovuoto mm. 150x300

C006852030

Buste goffrate per sottovuoto mm. 200x300

C006852535

Buste goffrate per sottovuoto mm. 250x350

C006853040

Buste goffrate per sottovuoto mm. 300x400

C006850200

Rotoli goffrati mm. 200 lunghezza mt. 6

C006850300

Rotoli goffrati mm. 300 lunghezza mt. 6

C006820025

Confezionatrice sottovuoto mod. "S250 Basic"
corpo in ABS rinforzato con filtro di protezione
liquidi - capacità di aspirazione 15 lt/m - monofase 220W
barra saldante cm. 25 - a norma CE

**C006830046**

Confezionatrice sottovuoto mod. "S460"
corpo in alluminio e acciaio inox - con filtro di protezione
liquidi - capacità di aspirazione 27 Lt/Min
tripla barra saldante da cm. 46 - a norme CE

**C006840033**

Confezionatrice sottovuoto mod. "Jolly steel"
corpo in acciaio inox - capacità di aspirazione 15 Lt/Min
barra saldante cm. 33 - a norma CE

**L002320045**

Perdix 18, dispenser manuale a freddo per
bobine da 1500 mt, con dispositivo taglio film,
larghezza max bobina 500 mm.

L002325045

Pellicola da 1500 mt,
larghezza 450 mm.

L002329030

Alluminio per alimenti in scatola
dispenser 150 mt, larghezza 300 mm.

**L002318030**

Dispenser Vitafilm in metallo per pellicole
da 300 mt e larghezza di 300 mm.

L002322030

Pellicola da 300 mt, larghezza 300 mm.



AC30350290

Ravvivamole Sievert lunghezza mm. 290

*Grinding - wheel dresser***AC30351290**

Rotelle di ricambio per ravvivamole Sievert

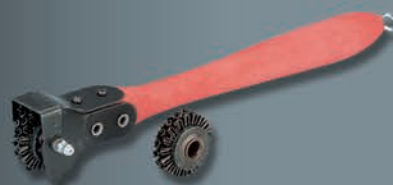
Spare part**AC30340300**

Pietra MAB 300 x 30 x 80 gr. 400

Whet stone**AC30310250** - 250 x 40 x 30**AC30310300** - 300 x 40 x 30**AC30310400** - 400 x 40 x 30

Mola in corindone per lucidatura gr. 60 rinforzate

Grinding wheel**AC30320300** - 300 x 40 x 50**AC30320355** - 355 x 40 x 50**AC30320406** - 406 x 40 x 50**AC30320508** - 508 x 40 x 50**AC30320610** - 610 x 40 x 50**AC30320710** - 710 x 40 x 50

Mole originali MAB in alundum vetrificato per affilatura gr. 90

Grinding wheel**L002285000**

Affilatrice elettrica semiprofessionale per coltelli DMS, mola in ceramica brevettata, corpo in acciaio inox made in Germany

**L002278000**

Affilatoio professionale diamantato "RedSteel II" con supporto inox per fissaggio al tavolo di lavoro

**L002276000**Affilatrice elettrica, con spazzola abrasiva lamellare e feltro, 600 W
Sharpening machine**L002277000**Affilatrice elettrica, con nastro abrasivo a secco e feltro, 600 W
Sharpening machine

PROFESSIONAL

SERIES



P003626115
Grembiule in PE 25 my
cm. 115x76

P003626145
Grembiule in PE 25 my
cm. 145x76

P003627130
Grembiule in PE 60 my
cm. 130x76

P004626115 - BLU
Grembiule in PE 25 my
cm. 115x76

P004626145 - BLU
Grembiule in PE 25 my
cm. 145x76

P004627130 - BLU
Grembiule in PE 60 my
cm. 130x76



P003629000
Impermeabile in PE



P00364300
Copriscarpe in PE Blu



P003591000
Guanti in vinile, non sterili
TG. S - M - L

P004591000 - BLU
Guanti in vinile, non sterili
TG. S - M - L

P003541000
Mascherina monouso



P003592000
Guanti in lattice, non sterili
TG. S - M - L

P004592000 - BLU
Guanti in lattice, non sterili
TG. S - M - L

P003593000
Guanto PE monouso



P003534000
Elastici in poliuretano
per guanti in acciaio

P004534000 - BLU
Elastici in poliuretano
per guanti in acciaio

P003539094
Matita Faber-Castell
per carne, colore blu

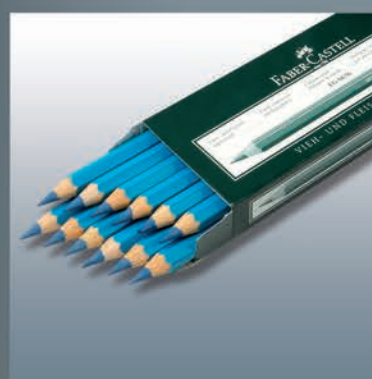

ARTICOLI MONOUSO
SERIES

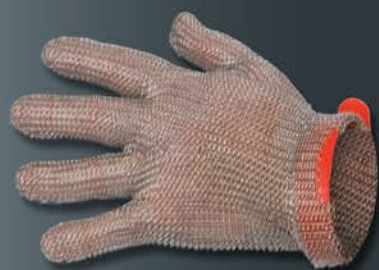

- Extra small
- Small
- Medium
- Large
- Extra large

**P003528000**

Guanti Niroflex, a norme CE
5 dita reversibile mis. XS - S - M - L - XL •

P003533000

Guanto Niroflex, a norme CE
5 dita reversibile con manicotto cm 15
mis. XS - S - M - L •

**P003579000**

Guanti antitaglio "Tuffshield Evolution" in filato composito brevettato Dyneema, fibra di vetro, acciaio inossidabile e poliammide antibatterica - Certificati per il contatto con alimenti. TG. 7 / 8 / 9 / 10

**P003595000**

Sottoguanti in cotone con polsino

**P003583000**

Guanti Ansell Edmont, duzmor 45, a norme CE, per alimenti in lattice naturale taglia 8 1/2 - 9 1/2

**P003537000**

Portacoltelli in plastica bianca composto di cintura e gancio per affilatoio

**P003538000**

portacoltello da cintura a 1 posto in plastica bianca

**P003596000**

Sottoguanto in cotone extra, lunghezza cm. 31

**P003535000**

Manicotto in policarbonato mis. L - XL •

**P003669000**

Levigatore per taglieri in plastica

P003669001

Lama di ricambio per levigatore

**P003586010**

Guanto anticalore in tessuto cotone-poliestere rivestito in nitrile resistente fino a 250° lunghezza 35 cm. a norme CE taglia 10

**P003539000**

Elmetto di sicurezza bianco a norme CE

• I codici delle misure alternative li troverete sul listino prezzi.

Measure code numbers are available on the price list.

SICUREZZA
SERIES



by Honeywell

**KCL0754000**

Guanti KCL mod. "VeroChem"
in nitrile - spessore mm. 0,28.
Estremamente soffici ed elastici,
ottima flessibilità ed elevata calzabilità.
Esente da sostanze allergizzanti.
Certificati per il contatto
con sostanze alimentari
Made in Germany.
TG. 7 - 8 - 9 - 10

**KCL0693010**

Guanti KCL mod. "TeboCold"
in Thinsulate 100g, PVC, polyamide
e poliestere - Spessore mm. 3,30
Protezione dal freddo fino a -50 °C
secondo la normativa EN 511
Eccellente comfort e molto resistenti
Certificati per il contatto
con sostanze alimentari
Made in Germany. TG 10

**KCL0451000**

Guanti KCL mod. "Camatex"
in lattice naturale - Spessore mm. 1,38
Eccellente grip con prodotti bagnati,
flessibilità alle basse temperature,
elasticità e riduzione dell'affaticamento
Ideali per il settore ittico - Palmo con
superficie antiscivolo e interno in cotone
Certificati per il contatto con sostanze alimentari
Made in Germany. TG 7 - 8 - 9 - 10

**KCL0738010**

Guanti KCL mod. "Tricotril Winter"
in nitrile e lana - Spessore mm. 2,00
Protezione dal freddo per periodi
non eccessivamente lunghi fino a
-20 °C - Molto resistenti, ottimo grip
e destrezza - Certificati per il
contatto con sostanze alimentari
Made in Germany. TG 10

**KCL0954010**

Guanti KCL mod. "KarboTECT"
in fibra para-aramid/carbon e
manichetta in pelle
Lunghezza mm. 380
Eccellente isolamento termico
fino a 350 °C - Alta resistenza al taglio
Certificati per il contatto con
sostanze alimentari
Made in Germany. TG 10

**P003510060**

Corpetto Manulatex, Flexinox
placche di acciaio inox, reversibile
a norme CE - Misure cm. 72x45

P003512076

Corpetto Manulatex, Flexinox
placche di acciaio inox, reversibile
a norme CE - Misure cm. 80x55

**P003514076**

Corpetto Niroflex
in maglia di acciaio inox,
a norme CE - Misure cm. 75x45

P003514080

Corpetto Niroflex
in maglia di acciaio inox,
a norme CE - Misure cm. 80x55

**P003620115**

Grembiule in poliuretano bianco
a norme CE mis. 90 x 115

P003625110

Grembiule in PVC bianco
mis. 75 x 110

P003621120

Grembiule in nitrile bianco
mis. 90 x 120

SICUREZZA

SERIES

P003642000

Scarpa di sicurezza con tomaia in microtech,
suola in PU monodensità antiscivolo,
a norme CE con puntale in acciaio mis. 36 ÷ 47 •

**P003646000**

Sabot di sicurezza con tomaia in pelle Fly forata,
suola in PU monodensità antiscivolo,
a norme CE con puntale in acciaio mis. 35 ÷ 47 •



• I codici
delle misure
alternative li
troverete sul
listino prezzi.

*Measure code
numbers are
available on the
price list.*

P003640000

Stivale in PVC/nitrile bianco,
a norme CE mis. 37 ÷ 46 •

**P003641000**

Stivale in PVC/nitrile bianco,
con puntale in acciaio, a norme CE mis. 37 ÷ 46 •



SICUREZZA

SERIES

**P003765040**

Spazzola Hygenia, sterilizzabile
mm. 400 x 48

P003760027

Spazzola Hygenia, sterilizzabile
mm. 270 x 70

P003765028

Spazzola Hygenia, sterilizzabile
mm. 280 x 50

**P003700019**

Spazzola per ceppo Hygenia
con lamelle in acciaio zincato

**P003750020**

Spazzola Hygenia, sterilizzabile
mm. 206 x 70

P003755018

Spazzola Hygenia, sterilizzabile
mm. 184 x 64

**P003668060**

Spingiacqua Hygenia, sterilizzabile cm 60

P003665040

Spingiacqua Hygenia, sterilizzabile cm 40

P003780014

Manico per spazzole e spingiacqua
Hygenia in alluminio rivestito cm. 140

**P003772040**

Spazzola Hygenia sterilizzabile
mm. 400 x 60 x 65

P003770030

Spazzola Hygenia sterilizzabile
mm. 300 x 70 x 30

**P006155055**

Spingiacqua in polipropilene cm 55

P006520014

Manico in alluminio per spingiacqua cm. 140



SICUREZZA

SERIES



SIEGER®

MONOPOL®

WESTMARK®



SG00616000

Cavatappi "Monopol Fino"
finitura satinata



SG00624000

Cavatappi "Monopol Bacchus"
finitura satinata



SG00616500

Cavatappi
"Monopol Brunello"
finitura satinata

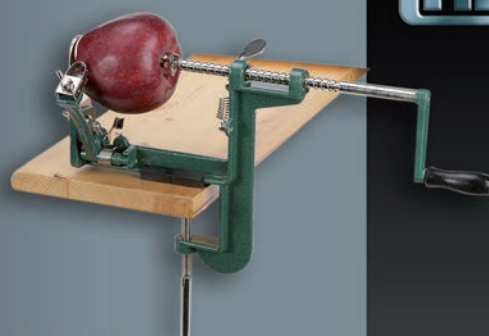

SG00114300

Pela mela "Westmark" con morsetto
per fissaggio al tavolo,
ideale anche per le patate.



BR00597000

Apriostriche Birambeau ariane



C003120000

Cavatappi cameriere



C003184000

Rompinoci cromato



C003119000

Cavatappi "Tavernello"



C003117000

Cavatappi "Skylab"



C003115000

Cavatappi "Sultano"

SIEGER®

MONOPOL

WESTMARK®



Per rinfrescare e mantenere alla temperatura ideale il vino. Prima dell'utilizzo conservare il Winesceptre per almeno tre ore in freezer.

Costruito interamente in speciale acciaio inox.



HWA0501
Winesceptre Grappolo
Standard box



ALS0034
Winesceptre Grappolo dorato
Luxury box



ALS0002
Winesceptre Bouchon
Standard box



ALS0026
Winesceptre Crystal
diamond, Ambra
Hard cover box



ALS0023
Winesceptre Crystal
diamond, Nero
Hard cover box



ALS0029
Winesceptre Crystal
diamond, Rubino
Hard cover box



ALS0020
Winesceptre Crystal
diamond, Zaffiro
Hard cover box



ALS0035
Winesceptre Crystal
diamond, Dorato
Luxury box



ALS0017
Winesceptre Golfball
Standard box



ALS0037
Winesceptre Corporate
Standard box



ALS0038
Winesceptre supporto da
freezer completo di 6 pz. HWA 501

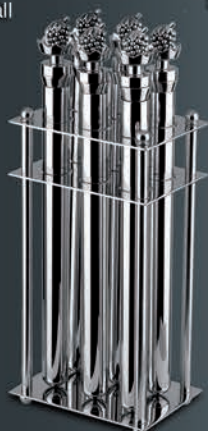

ALS0039
Winesceptre supporto da
freezer per 12 pz. vuoto



ALS0041
Winesceptre supporto da tavolo



Standard box



Hard cover box



Luxury box
Cofanetto in legno di ciliegio

Wine Sceptre®

B002445055

Poche monouso cm. 55

**B002450051**

Serie assortita di 10 punte per poche in polycarbonato

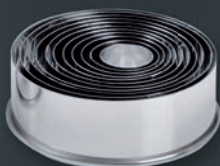
**B007845100**Set coppapasta rigato
11 pezzi, Ø cm. 2 a cm. 9**B007845700**Set coppapasta lisci
11 pezzi, Ø cm. 2 a cm. 9**B000799016**

Raschietto in plastica cm. 16

**B002438030**

Poche nylon cm. 35

B002438035

Poche nylon cm. 40

B002438040

Poche nylon cm. 45

B002475011Raschietto inox
lama tonda cm. 11**B002476011**Raschietto inox
lama retta cm. 11**B002423030**

Pennello in plastica alimentare cm. 30

**B002433040**

Pennello in plastica alimentare cm. 40

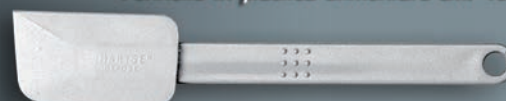
**B002478025**

Spatola maryse cm. 25

**B002473025**

Spatola melamina cm. 30

**B002474030**

Spatola melamina cm. 35

**B002452000**Punte per poche
diam. mm. 6-8-10-12-14**B002453000**Punte per poche, scanalate,
diam. mm. 6-8-10**T000643025**Termometro a penna,
inox -40 + 40 °C**T000519064**Termometro a gancio
-40 + 40 °C diam. mm. 64**T000087060**Termometro in resina con sonda
-40 + 40 °C diam. mm. 60**T000518064**Termometro con supporto inox
-40 + 40 °C diam. mm. 64

**AG02182021**

Cesoia per potare a doppio taglio, mm. 210

**AG02189019**

Cesoia per potare a battente, lama tefflonata, mod. Patin 4, mm. 190

**AG02183020**

Cesoia per potare a doppio taglio con fulcro disassato, mm. 200

**AG02184022**

Cesoia per potare a lame intercambiabili, mm. 220

**AG01112021**

Cesoia professionale a cuneo lama dritta cm. 21

**AG02187021**

Cesoia per giardino, manico in nylon, mm. 210

**AG01612021**

Cesoia professionale a cuneo lama curva cm. 21

**AG02186000**

Cesoia per potare forgiata, con fermadado, cm. 19•21•23

**AG02112021**

Cesoia professionale a by-pass cm. 21

**AG02228011**

Coltello innesto, cassa ottone, lama curva, mm. 55

**AG02226011**

Coltello innesto, manico abs, lama curva, mm. 55

**AG02230065**

Coltello innesto professionale con paletta, manico legno, lama mm. 65

**AG02227065**

Coltello innesto professionale, manico legno, lama mm. 65

**AG02229065**

Coltello innesto professionale, manico ABS, lama mm. 65,

**AG02231070**

Roncola professionale, manico legno, lama mm. 70

AGRICOLTURA

AG02179080

Tagliarami a battente, lama curva,
mm. 800

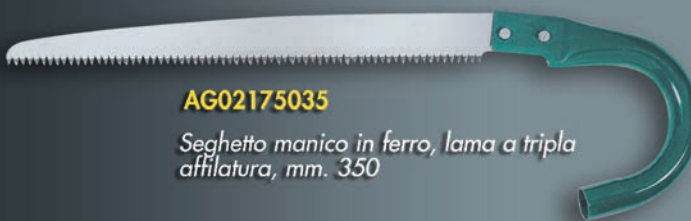
**AG02175035**

Seghetto manico in ferro, lama a tripla
affilatura, mm. 350

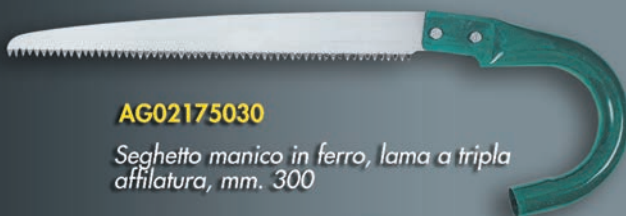
**AG02175030**

Seghetto manico in ferro, lama a tripla
affilatura, mm. 300

**AG02177020**

Seghetto chiudibile manico in plastica,
lama a tripla affilatura, mm. 200

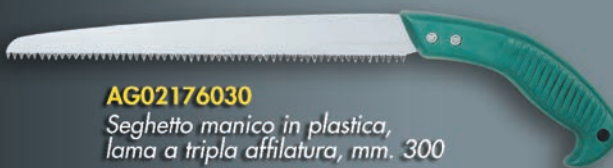
**AG02176030**

Seghetto manico in plastica,
lama a tripla affilatura, mm. 300

**AG02176025**

Seghetto manico in plastica,
lama a tripla affilatura, mm. 250

**AG02180080**

Tagliarami a battente, lama retta,
mm. 800

**AG02210050**

Macete Forgiato con fodero cm. 50

**AG02210040**

Macete Forgiato con fodero cm. 40

**AG07522075**

Forbice tagliasiepe professionale
cm. 75

AG06022060

Forbice tagliasiepe professionale
cm. 60

AGRICOLTURA

**MA40220012**

Espositore 12 pz. cesoie
serie giardino:
MA30160016 - pz. 4
MA30190019 - pz. 4
MA31190019 - pz. 4

**MA30230012**

Espositore 12 pz. cesoie
serie professional:
MA36210021 - pz. 4
MA35210021 - pz. 4
MA33190019 - pz. 4

**MA40210021**

Cesoia vendemmia, tipo pesante,
lame inox titanium coated cm. 21

**MA35210021**

Cesoia vendemmia, tipo pesante,
lame inox cm. 21

**MA36210021**

Cesoia vendemmia, m/co alluminio,
tipo pesante, lama inox cm. 21

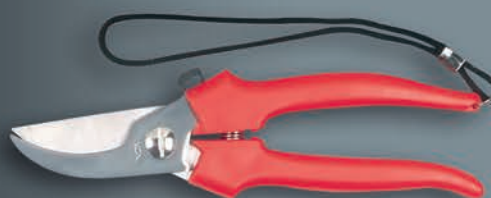
**MA31190019**

Cesoia giardino/potare, lame inox cm. 19

**MA30160016**

Cesoia giardino/cogliuva, lame inox cm. 16

**MA33195019**

Cesoia cogliuva cm. 19

**MA30190019**

Cesoia giardino/cogliuva, lame inox cm. 19

**MA33194016**

Cesoia cogliuva/agrumi cm. 16

**MA33190019**

Cesoia cogliuva lame inox, strette, cm. 19



MA11180018

Espositore 18 pz. forbici serie titanium ultra

5" - pz. 6

7" - pz. 6

8" - pz. 6



MA11175050

Forbici lavoro inox titanium coated 5"



MA11171070

Forbici lavoro inox titanium coated 7"



MA11173080

Forbici sartina inox titanium coated 8"



MA11174090

Forbici sartina inox titanium coated 9"



P230/312
Pelle moderne 3 1/2"



U350/312
Unghie moderne 3 1/2" microdentata



P235/312
Pelle moderne punta lancia 3 1/2"



U355/312
Unghie moderne punta lancia 3 1/2"



P210/312
Pelle gambi esagonali 3 1/2"



U355/400
Unghie moderne punta lancia 4" microdentata



P210/400
Pelle gambi esagonali 4"



U310/312
Unghie gambi esagonali 3 1/2" microdentata



P215/312
Pelle esagonali punta lancia 3 1/2"



U310R/312
Unghie gambi esagonali punte rette 3 1/2" microdentata



T400/414
Pedicure mezze tonde 4 1/4"



U340/312
Unghie francesi pesanti 3 1/2" microdentata
U340/400
Unghie francesi pesanti 4 1/2" microdentata

**R150/312**

Ricamo coda leone manico dorato 3 1/2"

**B610/300**

Baby mezza tonde 3"

**R140/312**

Ricamo fiorato manico dorato 3 1/2"

**N520/312**

Pelinaso pallino 3 1/2"

**RCP/312** Ricamo cicogna dorata ala nichelata 3 1/2"**RCP/414** 4 1/4" **RCP/612** 6 1/2"**N520/400**

Pelinaso 4"

**S700/400**

Silhouette 4"

**R100/312** Ricamo retto 3 1/2"**R100/400** Ricamo retto 4"**BFF/412**

Baffi 4 1/2"

**R120/400** Ricamo anelli larghi 4"**R120/412** Ricamo anelli larghi 4 1/2"**UF100/800** Ufficio 8"**UF100/900** Ufficio 9" **UF100/1000** Ufficio 10"

POMONI

F.lli POMONI
Forbici di
Alta Qualità

Made in



premana

**M100/500** Merciaio 5"**M100/512** Merciaio 5 1/2" **M100/600** Merciaio 6"**SI100/600** Sartina 6"**SI100/700** Sartina 7" **SI100/800** Sartina 8"**L100/400** Lavoro 4"**L100/412** 4 1/2" **L100/500** 5" **L100/512** 5 1/2"**L100/600** 6" **L100/612** 6 1/2" **L100/700** 7"**W100/600** Forbice microdentata 6"**W100/700** 7" **W100/800** 8" **W100/900** 9"**LD200/600X**

Lavoro inox M/CO nylon 6"

**W200/800**

Forbice cromata qualità extra 8"

**SID200/700X** Sartina inox M/CO nylon 7"**SID200/800X** Sartina inox M/CO nylon 8"**W300/800**

Forbice cromata con molla qualità extra 8"

**SD100/900X** Sarto inox M/CO nylon 9"**SD100/1000X** Sarto inox M/CO nylon 10"**S100/800** Sarto cromato qualità extra 8"**S100/900** Sarto cromato qualità extra 9" **S100/1000** Sarto cromato qualità extra 10"

F.lli POMONI
Forbici di
Alta Qualità

Made in



**U350/312X**

Unghe moderne inox 3 1/2" microdentata

**P230/312X**

Pelle moderne inox 3 1/2"

**U340/312X**

Unghe francesi pesanti inox 3 1/2" microdentate

U340/400X

Unghe francesi pesanti inox 4 1/2" microdentate

**P235/312X**

Pelle moderne inox punta lancia 3 1/2"

**L100/500X** Lavoro inox 5"**L100/600X** Lavoro inox 6"**L100/700X** Lavoro inox 7"**SI100/700X**

Sartina inox 7"

**U355/312X**

Unghe moderne inox punta lancia 3 1/2"

**U355/400X**

Unghe moderne inox punte lancia 4" microdentata

**N520/400X**

Pelinaso inox 4"

**T400/414X**

Pedicure mezze tonde inox 4 1/4"

**BFF/412X**

Baffi inox 4 1/2"



F.lli POMONI
Forbici di
Alta Qualità

Made in

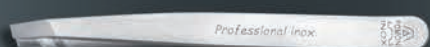

**PN110X**

Pinzetta INOX obliqua cm. 8

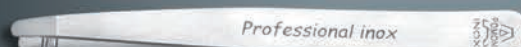
**PN300X**

Pinzetta INOX tonda cm. 9,5

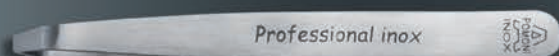
**PN500X**

Pinzetta INOX granchio cm. 9,5

**PN100X**

Pinzetta INOX obliqua cm. 9,5

**PN200X**

Pinzetta INOX retta cm. 9,5

**PN400X**

Pinzetta INOX a punta cm. 9,5

**PN100XFS**

Pinzetta INOX obliqua cm. 9,5 Sublimate Fantasy

**PN100X - 4005**

Pinzetta INOX obliqua cm. 9,5 Vari Colori

**TU100/90X**

Tagliaunghie inox per piedi

**TU100/60X**

Tagliaunghie inox per mani

**PN100X 24**

Espositore 24 Pinzette INOX oblique Colori Assortiti

**TU100/24X**

Display tagliaunghie 24 pezzi

**EDOL100/12**

Display dosatori olio tecnico, speciale per forbici e rasoi, con pennello applicatore



F.lli POMONI
Forbici di
Alta Qualità

Made in



**TR100/110-7X**

Tronchese pelle inox
incassato cm. 11

**TR200/100X**

Tronchese unghia inox
cm. 10

**TR200/110X**

Tronchese unghia inox
cm. 11

**TR200/120X**

Tronchese unghia inox
cm. 12

**TR200/130X**

Tronchese unghia inox
cm. 13

**TR300/110X**

Tronchese unghia inox
cm. 11

**TR300/140X**

Tronchese unghia inox
cm. 14

**TR400/110X**

Tronchese unghia incarnita
inox cm. 11

**TR400/140X**

Tronchese unghia incarnita
inox cm. 14

**PRS100/512X**

Forbice sfoltire inox 5,5"

**PRS200/512X**

Forbice sfoltire doppia dentatura inox 5,5"

**PR100/512X**

Forbice parrucchiere inox 5,5"

**PR100/600X**

Forbice parrucchiere inox 6"

**PR100/612X**

Forbice parrucchiere inox 6,5"

**E500/14**

Espositore completo 144 pezzi

**E400/36X**

Espositore 36 pezzi inox

**E300/12X**

Espositore 12 pezzi inox



F.lli POMONI
Forbici di
Alta Qualità

Made in



**ASN 300/4**

Astuccio manicure in vera pelle
con 4 pezzi inox - colore nero

**ASN 210/7**

Astuccio manicure in vera pelle con 7 pezzi inox - colore nero

ASB 210/7

Astuccio manicure in vera pelle con 7 pezzi inox - colore bordeaux

**ASN 100/5**

Astuccio manicure in vera pelle
con 5 pezzi inox - colore nero

ASB 100/5

Astuccio manicure in vera pelle
con 5 pezzi inox - colore bordeaux

**ASN 200/5**

Astuccio manicure in vera pelle
con 5 pezzi inox - colore nero

ASB 200/5

Astuccio manicure in vera pelle
con 5 pezzi inox - colore bordeaux

**ASN 120/9**

Astuccio manicure in vera pelle
con 9 pezzi inox - colore nero

ASB 120/9

Astuccio manicure in vera pelle
con 9 pezzi inox - colore bordeaux

ASN 110/8

Astuccio manicure in vera pelle
con 8 pezzi inox - colore nero

ASB 110/8

Astuccio manicure in vera pelle
con 8 pezzi inox - colore bordeaux

 POMONI

F.lli POMONI
Forbici di
Alta Qualità

**F001151010**

Tronchese orig. solingen per pelle, incassato cm. 10

FI01151010

Tronchese orig. solingen inox per pelle, incassato cm. 10

**F001155011**

Tronchese orig. solingen per unghie cm. 11

**F001153010**

Tronchese orig. solingen per pelle, sovrapposto cm. 10

FI01153010

Tronchese orig. solingen inox per pelle, sovrapposto cm. 10

**F001155013**

Tronchese orig. solingen per unghie cm. 13

**F001152010**

Tronchese orig. solingen per unghie cm. 10

**F001157011**

Tronchese orig. solingen per unghie cm. 11,5

FI01157011

Tronchese orig. solingen inox per unghie cm. 11,5

F001157013

Tronchese orig. solingen per unghie cm. 13,5

**F001152011**

Tronchese orig. solingen per unghie cm. 11

**F001158014**

Tronchese orig. solingen per unghie, obliquo cm. 14,5

**F001152012**

Tronchese orig. solingen per unghie cm. 12

**F001156014**

Tronchese orig. solingen per unghie, cm. 14,5

**F001152013**

Tronchese orig. solingen per unghie cm. 13

**F001154014**

Tronchese orig. solingen per unghie cm. 14,5



WP92005050
Forbice ricamo inox 5"



WP92006060
Forbice lavoro inox 6"

WP92007070
Forbice sarto inox 7"



WP92008080
Forbice sarto inox 8"



WP920010100
Forbice sarto inox 10"



WP9200100100
Forbice sarto inox mod. pesante 10"



WP80000080
Forbice cucina inox 8"



PERFECTION

SERIES





WM00500050

Forbice parrucchiere cobalto inox 5"



WI08206565

Forbice parrucchiere cobalto inox 6 1/2"



WI08206060

Forbice parrucchiere inox 6"



WI08135555

Forbice parrucchiere inox 5 1/2"



WI08135050

Forbice parrucchiere inox 5"



WI08249060

Forbice parrucchiere per
soltire inox, a due lame dentate 6"



WI08135355

Forbice parrucchiere per
soltire inox, a una lama dentata 5 1/2"

MILLENNIUM - ROSE-LINE
SERIES





WP00650065

Forbice parrucchiere inox 6 1/2"



WP00555055

Forbice parrucchiere inox 5 1/2"



WP00600060

Forbice parrucchiere inox 6"



WP0000550055

Forbice parrucchiere inox 5 1/2"



WP00500050

Forbice parrucchiere inox 5"



WN01550055

Forbice parrucchiere inox 5 1/2"



WN01500050

Forbice parrucchiere inox 5"



W100100KIO

Rasoio mezza lama originale Kismet completo di 6 lame ricambio



W100CNC1R0

Rasoio "click-n-cut" completo di lama liscia + lama modellante

ONLINE PROFESSIONAL SERIES





F001134120
Forbice per modellisti 12"



F001137070
Forbice orefice 7"



F001136090
Forbice per cuoio con molla 9"



F001138070
Forbice orefice 7"



F001135080
Forbice per gomma doppia curva 8"



F001132080
Forbice per cuoio, lama dentata 8"



F001133070
Forbice per gomma, lama curva 7"



F001132100
Forbice per cuoio, lama dentata 10"



F001139000
Forbice modello scarperia 5" • 6" • 7"
manici verniciati

EXCELLENT
SERIES

**F001123000**

Rasoio a mezza lama

**F001251015** Lima diam. cm. 15**F001251013** Lima diam. cm. 13 **F001251018** Lima diam. cm. 18**F001253018** Lima fresata cm. 18**F001253020** Lima fresata cm. 20**F001058065**

Forbice tagliacampioni, ghisa 6 1/2

**F001256012** Lima al silicio cm. 12 in buste da 10 pz.**F001256018** Lima al silicio cm. 18 in buste da 10 pz.**F001059080**

Forbice tagliacampioni, acciaio 8"

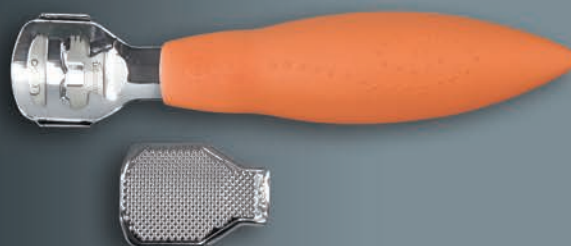
**F001193000**

Tagliacalli originale credo

**F001065075**

Forbice tagliacampioni, acciaio 7 1/2

**F001194000**

Lame ricambio per tagliacalli, conf. 10 pz.

**F001181000** Tagliaunghie Trim, sfuso**F001182000** Tagliaunghie Trim, su cartella da 12 pz.**F001184000** Tagliapelle Vega**F001052080**

Forbice casa inox, manico plastica 8"

**F001183000** Tagliaunghie Trim curvo, per piedi, su cartella da 12 pz.**F001185000** Tagliaunghie Vega con manico

EXCELLENT
SERIES